

Volume 47 ◦ Issue 1 ◦ March 2025

# Cumhuriyet Medical Journal



Official Journal of Sivas Cumhuriyet University  
Faculty of Medicine

**e-ISSN: 1305-0028**

[cmj.cumhuriyet.edu.tr](http://cmj.cumhuriyet.edu.tr)

Cumhuriyet Medical Journal (CMJ) is a peer-reviewed journal and is published four times a year, in March, June, September and December. It aims to provide readers with up-to-date information on basic, internal, and surgical science research, expert opinions, and diagnostic and treatment techniques. It publishes English-language articles both national and international. Using Open Journal Systems software, it is published online in an open journal publishing format. By collaborating with a nationally and internationally renowned referee group, it seeks to consistently enhance its quality and draw in a larger readership. It considers recommendations from all scientists interested in working with us to improve our journal. Cumhuriyet Medical Journal is indexed in the [Index Copernicus Master List](#).

### **Cumhuriyet Medical Journal Editorial Board**

Cumhuriyet Medical Journal adheres to the general rules applicable to manuscripts submitted to biomedical journals. Of all article drafts submitted to CMJ, those that are publishable are subjected to a rigorous double-blind peer review process. Every article that is submitted is checked for compliance with the submission guidelines in a preliminary review. Articles that go through this procedure are sent to the chief editor for editorial assessment. The piece that the editor-in-chief evaluates is given to the section editor. The editor of the pertinent section will designate a minimum of two reviewers. Reviewers are chosen based on their evaluation interests and areas of experience. The reviewers are not made aware of the authors' identity. Through feedback, reviewers offer recommendations to the editors on the article's scientific worth, the procedures used, and the statistical analyses performed. The statistics editor receives articles that need a more in-depth examination of statistics. The pertinent section editor provides an overall assessment based on the cumulative feedback from the reviewers. The editorial board then assesses the piece and renders a definitive decision. The website is used to send recommendations, criticisms, and comments to the writers of the articles; the referees' identities are kept private. After being returned to the authors for revision, article contents are required to be resubmitted within 15 days with the appropriate changes made.

\* International Committee of Medical Journal Editors. General Rules for Manuscripts Submitted to Biomedical Journals: International Committee of Medical Journal Editors. Uniform Requirements for Manuscripts Submitted to Biomedical Journals: Writing and Editing for Biomedical Publications. Last update date: October 2008. Available: <http://www.icmje.org/index.html>.

## **INFORMATION TO AUTHORS**

### **Language**

The writing language of the journal is English. Articles must be written in English and contain English and Turkish titles, abstracts and keywords. Authors whose native language is not English should get help from an expert in English and scientific writing before submitting their articles. Manuscripts that do not meet basic language standards will be returned without preliminary review.

### **Register**

Articles must be sent to Cumhuriyet Medical Journal via Dergipark by the corresponding author. All authors must register with Dergipark. Manuscript files in Microsoft Word format (.doc, .docx) can be saved. There is no page limitation. If there is a problem while uploading the article files, the size of the article should be reduced, especially for articles containing figures. Registrations made by anyone other than the authors will not be accepted. The recording author will have taken all responsibilities in the recording and evaluation process. In case of technical problems during registration, support can be requested at [cumhuriyetmedicaljournal@cumhuriyet.edu.tr](mailto:cumhuriyetmedicaljournal@cumhuriyet.edu.tr).

### **Admission Requirements**

The publications to be submitted must not have been previously published elsewhere (except for abstracts, part of a published conference, thesis studies) and must not be under evaluation by another journal. The recording author will be responsible for all authors regarding the publication of the article. It is also the responsibility of the authors

to ensure that publications issued by a particular institution have the approval of that institution. Only the acceptance letter written by the editorial office indicates the acceptance date. Subsequent correspondence and corrections will be sent to the author(s) before publication unless otherwise required. Permission must be given by all authors for the publication to be published.

## **Assessment**

All evaluated studies must meet certain academic standards. Incoming articles will first be pre-evaluated by the journal secretary in terms of compliance with the writing rules. After the eligible articles are evaluated by the editor-in-chief, they will be evaluated by referees who are not known to the authors and are not from the same institution as the author. Author information is not shown to reviewers. Reviewers are given 7 days to accept the invitation and 15 days for evaluation. The evaluation period of your article may vary depending on the reviewers' acceptance rate.

## **PREPARATION OF ARTICLES**

### **1. Title Page**

- Article title (Turkish and English)
- Authors' full names, institutions and ORCID information (available at <https://orcid.org/>)
- Order of authors in the article
- Who is the corresponding author, contact information (e-mail address and phone number)
- Informed consent information obtained from participants included in the research.
- Author contributions (Concept, design, supervision, resources, materials, data collection, analysis, literature review, writing, critical review, other.)
- Financial support (If not, it should be written that there is none)
- If the article has been previously presented at the congress or the thesis has been published, this should be stated on the cover page. Full text printed articles are not accepted at the congress.

### **2. Conflict of Interest**

- All contributing authors must fill out the ICMJE form individually and the completed forms must be uploaded to the online system by the corresponding author. Form is available from <http://www.icmje.org/conflicts-of-interest/>.

### **3. Copyright Transfer Form**

The copyright transfer form must be signed by all authors and uploaded to the system. Cumhuriyet Medical Journal provides free access to its content from the journal's website and allows its content to be downloaded free of charge. Both anonymous and registered users can read and/or download articles. Unless otherwise noted, articles and journal content are licensed under a Creative Commons Attribution 4.0 International License.

### **4. Ethics Committee Approval**

The pertinent approval document needs to be submitted to the system along with any articles that need to be approved by the ethics committee. A petition declaring that authorization is not needed must be signed by the relevant author and uploaded to the system for articles that do not require clearance from the ethics committee.

### **5. Plagiarism Report**

Our journal's accepted similarity limit is 20%. The plagiarism report must also be uploaded to the system when the article is submitted.

## 6. Preparation of the Article

Formal rules for all types of writing:

- The length of the article depends on the type of article. Paper dimensions should be 8.5 × 11 inches with a 2.5 cm margin on all sides. Please use regular, plain font (12-point Times New Roman), justified, and number all pages consecutively. Indent or space paragraphs.
- Please number the lines.

Accepted article types:

1. **Original Research Article:** Research articles and systematic reviews, respectively; English Title, English Abstract, English Keywords, Turkish Title, Turkish Abstract, Turkish Keywords, Introduction, Materials and Methods, Results, Discussion, Conclusion, Acknowledgments, Authorship Contribution, Conflicts of Interest statement, References, Tables (inside the article and at the end of the article) and Figure Descriptions (figures must be uploaded to the system as separate files).
2. **Review:** Although they adhere to the format of a Research Article, they do not need to include sections on materials and methods, results, or discussion and may instead use other headings related to the topic.
3. **Case Report:** It should be structured as English Title, English Abstract, English Keywords, Turkish Title, Turkish Abstract, Turkish Keywords, Introduction, Case Report, Discussion, Conclusion, Acknowledgments, Authorship Contribution, Conflict Declaration, References, Tables and Figure Legends..

## SECTIONS OF THE ARTICLE

### Title and Abstract

An abstract must be provided in all articles. Abstracts of Research Articles should be structured with subheadings (Purpose, Methods, Results, and Conclusion). Word limit for abstract research paper is 250; 200 for case presentation.

### Keywords

According to MESH, 3 - 5 keywords should be provided. Turkish keywords should be taken from "bilim terimleri".

### Introduction

This section should not contain subheadings.

### Materials and Methods

This section should be written in enough detail to allow all procedures to be repeated. Authors should describe procedures and analytical techniques and identify the names and sources of all commercial products. It can be written by dividing it into subheadings.

In research requiring ethics committee permission, information regarding the permission (committee name, date and issue number) should be written in the materials and methods section. Case reports should include information that the informed consent/consent form was signed. Systematic review articles must comply with PRISMA guidelines. Authors should indicate this under the heading of materials and methods.

Information regarding statistical analyzes should be given under a separate subheading in this section and the statistical software used during the process should be specified.

### Results

Authors should refer to appropriate tables and figures when reporting statistical findings, and findings should be presented in a logical order. The data given in the table should not be completely repeated in the text, but the important results in the table should be written in the text and then the table should be referenced.

### Discussion

### Conclusions

### The Acknowledgements

If the study was supported by a grant or other funding, the name of the supporting organization and grant number should be stated.

All contributors who do not meet the authorship criteria recommended by the ICMJE ([www.icmje.org](http://www.icmje.org)) should be listed in the 'Acknowledgments' section.

### **Authorship Contribution**

It is recommended that everyone listed as an author meet the 4 authorship requirements recommended by the ICMJE. These conditions:

1. Concept/design of the study; or have made a significant contribution to the collection, analysis and interpretation of data for the study;
2. Having drafted the article or made critical reviews of important intellectual content;
3. Having reviewed and approved the final version of the article before publication;
4. Agree to be responsible for all aspects of the work to ensure that questions regarding the validity and accuracy of any part of the work are appropriately investigated and resolved.

The parts of the research that the authors contributed to should be written using their first and last name initials.

Ex: Design: A.E., E.F., T.T., Data Collection: A.E., T.T.

### **Conflicts of Interest Statement**

Identify possible conflicts of interest; if not, state that there is no conflict of interest.

### **References**

American Medical Association 11th edition style is preferred. The rules of this reference style are;

1. References should be indicated in the article with superscript Arabic numerals after punctuation marks. You can create a superscript number in Word by highlighting the number you want and clicking the superscript button in the Font section at the top of the screen.
2. The reference list should be given as a separate page at the end of the article. It should be left aligned and arranged in numerical order. The reference list should only include references mentioned in the text.
3. Pubmed ID (PMID) or Pubmed Central ID (PMCID) records of the articles should NOT be added to the reference list.
4. It is important to write doi numbers, if any.
5. In articles with 7 or more authors, the first 3 authors should be written and et al. should be added. In articles with 6 or fewer authors, all authors must be written.

#### 5. Example AMA 11th References

Book:

Author AA, Author BB. *Title of Book: Subtitle of Book*. Edition. Name of publisher; Year of publication.

E-Book:

Author AA, Author BB, Author CC. *Title of Book: Subtitle of Book*. Edition. Name of publisher; Year of publication.

Date accessed. URL

Journal Article:

Author AA, Author BB, Author CC. Title of article: lower case letter for subtitle. *Abbreviated Title of Journal*.

Year;Volume number(Issue number);page numbers. DOI.

### **Figures**

Figure titles should be written after the references in the article, and the figures should be uploaded to the system as separate files.

## **Tables**

Tables should be placed after the references in the text. Tables should NOT be uploaded as photographs (jpeg). It must be created using the insert table tool in Microsoft Word. The table name is above the table and explanations about the table content should be placed below the table.

## Journal Boards

### Editor in Chief

**Prof. Dr. H. Reyhan EĐİLMEZ**

Department of Pathology, Faculty of Medicine, Sivas Cumhuriyet University, Sivas, Türkiye  
ORCID:0000-0001-9666-0246  
E-mail: egilmezreyhan@gmail.com

### Editors

**Prof. Dr. Ali ŞAHİN**

Division of Rheumatology, Department of Internal Medicine, Faculty of Medicine, Sivas Cumhuriyet University, Sivas, Türkiye  
ORCID: 0000-0003-0743-5288  
E-mail: alisahin@cumhuriyet.edu.tr

**Prof. Dr. Mehmet H. ATALAR**

Department of Radiology, Faculty of Medicine, Sivas Cumhuriyet University, Sivas, Türkiye  
ORCID: 0000-0003-3076-8072  
E-mail: mhatar@gmail.com

### Assistant Editors

**Assoc. Prof. Ezgi AĐADAYI**

Department of Medical Education, Faculty of Medicine, Sivas Cumhuriyet University, Sivas, Türkiye  
ORCID: 0000-0001-9546-2483  
E-mail: ezgiagadayi@cumhuriyet.edu.tr

**Assoc. Prof. Musa POLAT**

Department of Physical Medicine and Rehabilitation, Faculty of Medicine, Sivas Cumhuriyet University, Sivas, Türkiye  
ORCID:0000-0002-8290-3697  
E-mail:musapolat@cumhuriyet.edu.tr

**Assist. Prof. Ramazan OĐuz YÜCEER**

Department of Pathology, Faculty of Medicine, Sivas Cumhuriyet University, Sivas, Türkiye  
ORCID: 0000-0002-9418-8862  
E-mail: r.yuceer66@hotmail.com

## **Surgical Sciences Section Editors**

### **Prof. Dr. Ali ÇETİN**

Department of Gynecology and Obstetric, İstanbul Haseki Education and Research Hospital, Health Science University, İstanbul, Türkiye

ORCID: 0000-0002-5767-7894

E-mail: dralicetin@yahoo.com

### **Assoc. Prof. Burçak SÖYLEMEZ**

Department of Neurosurgery, Faculty of Medicine, Sivas Cumhuriyet University, Sivas, Türkiye

ORCID: 0000-0001-8626-6915

E-mail: burci1986@gmail.com

## **Clinical Sciences Section Editors**

### **Prof. Dr. Ergün Haldun SÜMER**

Department of Public Health, Faculty of Medicine, Sivas Cumhuriyet University, Sivas, Türkiye

ORCID: 0000-0001-6690-7658

E-mail: hsumer@cumhuriyet.edu.tr

### **Prof. Dr. Nurullah ÇELİK**

Division of Endocrinology, Department of Pediatrics, Faculty of Medicine, Sivas Cumhuriyet University, Sivas, Türkiye

ORCID: 0000-0003-1583-6807

E-mail: ncelik@cumhuriyet.edu.tr

## **Basic Sciences Section Editors**

### **Prof. Dr. Ercan ÖZDEMİR**

Department of Physiology, Faculty of Medicine, Sivas Cumhuriyet University, Sivas, Türkiye

ORCID: 0000-0001-8231-1053

E-mail: eozdemir@cumhuriyet.edu.tr

### **Prof. Dr. Ayşe DEMİRKAZIK**

Department of Biophysics, Faculty of Medicine, Sivas Cumhuriyet University, Sivas, Türkiye

ORCID: 0000-0001-7224-2832

E-mail: dmrkzk@yahoo.com

## **Statistic Editor**

### **Assist. Prof. Ziyne ÇINAR**

Department of Biostatistic, Faculty of Medicine, Sivas Cumhuriyet University, Sivas, Türkiye

ORCID: 0000-0002-6641-4666

E-mail: zcinar@cumhuriyet.edu.tr



## Language Editors

### **Assoc. Prof. Erman BOZALI**

Department of Ophtalmology, Faculty of Medicine, Sivas Cumhuriyet University, Sivas, Türkiye  
ORCID: 0000-0001-7918-8381  
E-mail: ermanbozali@gmail.com

### **Assit. Prof. Fatma KAYA**

Department of English Language Teaching, Faculty of Education, Sivas Cumhuriyet University, Sivas, Türkiye  
ORCID:0000-0002-4040-0194  
E-mail: fhayta26@gmail.com

## Advisory Board

### **Prof. Dr. Ayhan KOYUNCU**

Department of General Surgery, VM Medical Park Maltepe Hospital, İstanbul, Türkiye  
ORCID: 0009-0003-1173-2549  
E-mail: sarper@bilkent.edu.tr

### **Prof. Dr. Binali ÇITAK**

Department of Public Health, Faculty of Medicine, Kafkas University, Kars, Türkiye  
ORCID: 0000-0003-2769-990X  
E-mail: bb.catak@hotmail.com

### **Prof. Dr. Cem ÇANKAYA**

Department of Ophthalmology, Faculty of Medicine, Malatya İnönü University, Malatya, Türkiye  
ORCID: 0000 0002 7716 0438  
E-mail: cem\_cankaya@yahoo.com

### **Prof. Dr. Çiğdem ELMAS**

Department of Histology and Embryology, Faculty of Medicine, Gazi University, Ankara, Türkiye  
ORCID: 0000-0002-8857-0918  
E-mail: 00cigdem@gmail.com

### **Prof. Dr. Ergün PINARBAŞI**

Department of Medical Biology, Faculty of Medicine, Sivas Cumhuriyet University, Sivas, Türkiye  
ORCID: 0000-0002-3863-9470  
E-mail: ergunp@gmail.com

### **Prof. Dr. Fatma YÜCEL BEYAZTAŞ**

Department of Forensic Medicine, Faculty of Medicine, Sivas Cumhuriyet University, Sivas, Türkiye  
ORCID: 0000-0001-9734-8908  
E-mail: fbeyaztas@yahoo.com

### **Prof. Dr. Fatma Mutlu Kukul GÜVEN**

Department of Emergency Medicine, Faculty of Medicine, Kastamonu University, Kastamonu, Türkiye  
ORCID: 0000-0003-3755-6021  
E-mail: mutlukukul@gmail.com

### **Prof. Dr. Gülcan GÜRER**

Department of Physical Medicine and Rehabilitation, Faculty of Medicine Aydın Adnan Menderes University, Aydın, Türkiye  
ORCID: 0000-0001-8287-2264  
E-mail: gurergulcan@yahoo.com.tr

**Prof. Dr. Hacı Ömer ATEŞ**

Department of Medical Biology, Faculty of Medicine, Tokat Gaziosmanpaşa University, Tokat, Türkiye  
ORCID:0000-0003-4266-393x  
E-mail: omer.ates@gop.edu.tr

**Prof. Dr. Hamiyet ALTUNTAŞ**

Department of Medical Biology, Faculty of Medicine, Kayseri Erciyes University, Kayseri, Türkiye  
ORCID: 0000-0001-6473-5813  
E-mail: donmezh@erciyes.edu.tr

**Prof. Dr. Haydar ERDOĞAN**

Department of Ophthalmology, Faculty of Medicine, Sivas Cumhuriyet University, Sivas, Türkiye  
ORCID: 0000-0002-9337-6968  
E-mail: herdogan65@gmail.com

**Prof. Dr. Hatice ÖZER**

Department of Pathology, Faculty of Medicine, Sivas Cumhuriyet University, Sivas, Türkiye  
ORCID: 0000-0001-6479-3626  
E-mail: haticozer@gmail.com

**Prof. Dr. İbrahim GÜL**

Department of Cardiology, Faculty of Medicine, Sivas Cumhuriyet University, Sivas, Türkiye  
ORCID: 0000-0003-1007-0961  
E-mail: dribrahimgul@hotmail.com

**Prof. Dr. İsmail KOÇYİĞİT**

Division of Nephrology, Department of Internal Medicine, Faculty of Medicine, Kayseri Erciyes University, Kayseri, Türkiye  
ORCID: 0000-0002-6654-4727  
E-mail: iikocyigit@gmail.com

**Prof. Dr. Levent CANKORKMAZ**

Department of Pediatric Surgery, Faculty of Medicine, Sivas Cumhuriyet University, Sivas, Türkiye  
ORCID: 0000-0003-1525-1470  
E-mail: lcankorkmaz@gmail.com

**Prof. Dr. Levent ÖZDEMİR**

Department of Public Health, Faculty of Medicine, Uludağ University, Bursa, Türkiye  
ORCID: 0000-0002-4330-8334  
E-mail: leventozdemir@uludag.edu.tr

**Prof. Dr. M. Aydın KETANİ**

Department of Histology and Embryology, Faculty of Veterinary, Dicle University, Diyarbakır, Türkiye  
ORCID: 0000-0002-1546-9747  
E-mail: maketani@gmail.com

**Prof. Dr. Nesrin TURHAN**

Department of Pathology, Bilkent City Hospital, Health Sciences University, Ankara, Türkiye  
ORCID: 0000-0001-6566-2695  
E-mail: nesrin.turhan@sbu.edu.tr

**Prof. Dr. Nebahat SEZER**

Department of Physical Medicine and Rehabilitation, Faculty of Medicine, Ankara Yıldırım Beyazıt University, Ankara, Türkiye  
ORCID: 0000-0003-0842-7108  
E-mail: nsezer1994@yahoo.com

**Prof. Dr. Nazif ELALDI**

Department of Infectious Diseases and Clinical Microbiology, Faculty of Medicine, Sivas Cumhuriyet University, Sivas, Türkiye  
ORCID: 0000-0002-9515-770X  
E-mail: nelaldi@cumhuriyet.edu.tr

**Prof. Dr. Özgür KASAPÇOPUR**

Division of Rheumatology, Department of Pediatrics, Faculty of Medicine, İstanbul University-Cerrahpaşa, İstanbul, Türkiye  
ORCID: 0000-0002-1125-7720  
E-mail: ozgurkc@iuc.edu.tr

**Prof. Dr. Özlem ŞAHİN**

Department of of Physical Medicine and Rehabilitation, Faculty of Medicine, Sivas Cumhuriyet University, Sivas, Türkiye  
ORCID: 0000-0002-9346-5477  
E-mail: sahinfr@yahoo.com

**Prof. Dr.Sait EĞRİLMEZ**

Ophthalmologist, İzmir, Türkiye  
ORCID: 0000-0002-6971-527X  
E-mail: saitegrilmez@gmail.com

**Prof. Dr. Serdar Savaş GÜL**

Department of Nuclear Medicine, Faculty of Medicine, Lokman Hekim University, Ankara, Türkiye  
ORCID: 0000-0003-4822-2588  
E-mail: gopnukleertip@gmail.com

**Prof. Dr. Serpil ÜNVER SARAYDIN**

Department of Histology and Embryology, Faculty of Medicine, Sivas Cumhuriyet University, Sivas, Türkiye  
ORCID: 0000-0001-7639-7487  
E-mail: unversaraydin@gmail.com

**Prof. Dr. Üner KAYABAŞ**

Department of Infectious Diseases and Clinical Microbiology, Kayseri City Health Practice and Research Hospital, Health Sciences University, Kayseri, Türkiye  
ORCID: 0000-0002-5323-0796  
E-mail: unerkayabas@hotmail.com

**Prof. Dr. Vedat SABANCIOĞULLARI**

Department of Anatomy, Faculty of Medicine, Sivas Cumhuriyet University, Sivas, Türkiye  
ORCID: 0000-0001-9059-6554  
E-mail: sabanci@cumhuriyet.edu.tr

**Prof. Dr. Zehra Zerrin ERKOL**

Department of Forensic Medicine, Faculty of Medicine, Bolu Abant İzzet Baysal University, Bolu, Türkiye  
ORCID: 0000-0003-0281-9389  
E-mail: zerrinerkol@gmail.com

**Prof. Dr. Zekiye HASBEK**

Department of Nuclear Medicine, Faculty of Medicine, Sivas Cumhuriyet University, Sivas, Türkiye  
ORCID: 0000-0002-8119-3363  
E-mail: hasbekz@yahoo.com

**Assoc. Prof. Ayla Uzun ÇIÇEK**

Department of of Child and Adolescent Mental Health and Diseases, Faculty of Medicine, Sivas Cumhuriyet University, Sivas, Türkiye

ORCID: 0000-0003-2274-3457

E-mail: dr.f.ayla@hotmail.com

**Assoc. Prof. Celal BÜTÜN**

Department of Forensic Medicine, Faculty of Medicine, Balıkesir University, Balıkesir, Türkiye

ORCID: 0000 0003 2738 6559

E-mail: celal.butun@balikesir.edu.tr

**Assoc. Prof. Evrim GÜL**

Department of Emergency Medicine, Faculty of Medicine, Fırat University, Elazığ, Türkiye

ORCID: 0000-0001-9049-5446

E-mail: evrimgl@yahoo.com.tr

**Assoc. Prof. Hakan IŞIK**

Department of Thoracic Surgery, Gulhane Medical Faculty, Health Sciences University, Ankara, Türkiye

ORCID: 0000-0002-7602-4434

E-mail: hakan\_hj@hotmail.com

**Assoc. Prof. Hilal IRMAK SAPMAZ**

Department of Anatomy, Faculty of Medicine, Tokat Gaziosmanpaşa University, Tokat, Türkiye

ORCID: 0000-0002-9821-1628

E-mail: hisapmaz@yahoo.com

**Assoc. Prof. İlknur UCUZ**

Department of of Child and Adolescent Mental Health and Diseases, Faculty of Medicine, İnönü University, Malatya, Türkiye

ORCID: 0000-0003-1986-4688

E-mail: ilknur\_27@yahoo.com

**Assoc. Prof. Seyit Ahmet ERTÜRK**

Department of Nuclear Medicine, Faculty of Medicine, Karadeniz Technical University, Trabzon, Türkiye

ORCID: 0000-0002-6030-9662

E-mail: seyitahmet1988@gmail.com

**Assist. Prof. Hasan TETİKER**

Department of Anatomy, Faculty of Medicine, Muğla Sıtkı Koçman University, Muğla, Türkiye

ORCID: 0000-0002-0059-7308

E-mail: hasantetiker@gmail.com

**Assist. Prof. Mahmut ÖZBEY**

Department of Thoracic Surgery, Faculty of Medicine, Sivas Cumhuriyet University, Sivas, Türkiye

ORCID: 0000-0001-8641-1772

E-mail: mnozbey\_90@hotmail.com

**Assist. Prof. Semiha CÖMERTOĞLU ARSLAN**

Department of of Child and Adolescent Mental Health and Diseases, Faculty of Medicine, Kahramanmaraş Sütçü İmam Üniversitesi, Kahramanmaraş, Türkiye

ORCID: 0000-0002-2296-5853

E-mail: drsemihacrs@gmail.com

**Assist. Prof. Serkan UYSAL**

Department of Thoracic Surgery, Faculty of Medicine, Hacettepe University, Ankara, Türkiye

ORCID: 0000-0002-1152-2854

E-mail: drsuysal@msn.com

# Cumhuriyet Medical Journal

Official Journal of the Sivas Cumhuriyet University Faculty of Medicine

Volume 47 Issue 1 December 2025

## Editorial

- World Health Organization Classification of Central Nervous System Tumors 1  
*Hatice Reyhan Eğilmez*

## Review

- The Genetics of Sexual Development Disorders 2  
*Malik Ejder Yıldırım*

## Systematic Review

- Artificial Intelligence in HIV Diagnosis and Treatment: A Comprehensive Review 10  
*Bahar Şenel, Hayati Beka*

## Research Article

- Investigation of The Prevalence of Tick-Borne Encephalitis Virus Antibodies in Patients with Preliminary Diagnosis of Crimean-Congo Hemorrhagic Fever 22  
*Murtaza Öz, Yasemin Çakır Kıymaz, Caner Öksüz, Binnur Bağcı, Ayşe Nur Pektaş, Turhan Turan, Seyit Ali Büyüktuna, Nazif Elaldi*

- Prevalence of Dyslipidemia at Onset and During Follow-Up in Pediatric Patients with Type 1 Diabetes Mellitus 26  
*Ayça Bilge Sönmez, Filiz Tütüncüler*

- Post-Earthquake PTSD: Identifying Key Risk Factors Eleven Months After the February 2023 Turkey Earthquakes 32  
*Yavuz Yılmaz, Erdi Bahadır*

- The Relationship Between Finger Ratio (2D:4D) and Criminal Behavior in Bipolar Disorder 41  
*Elif Emre, Sevler Yıldız, Suna Aydın, Düzgün Şimşek, Mehmet Gürkan Gürok*

## Case Report

- Very Early Use of Clozapine in a Case of Very Early-Onset Schizophrenia 49  
*Beza Nur Karal, Yahya Esad Özdemir, Ali Karayağmurlu*

- Tailored Treatments: Utilizing Anti-TNFs for Ankylosing Spondylitis and Essential Thrombocytosis 52  
*Dilara Bulut Gökten, Ridvan Mercan*

- Two Cases of Dermatomyositis with Anti-cN1A Antibody Positivity 55  
*Kubilay Tay, Zeynep Toker Dinçer, Kerem Parlar, Gökçen Unverengil, Serdal Uğurlu*

## Correction

- Surgical Treatment of Low-Grade Lumbar Spondylolisthesis 59  
*Hüseyin Doğu*



## World Health Organization Classification of Central Nervous System Tumors

Hatice Reyhan Eğilmez<sup>1,a,\*</sup>

<sup>1</sup> Department of Pathology, Faculty of Medicine, Sivas Cumhuriyet University, Sivas, Türkiye

\*Corresponding author

### Editorial

#### History

Received: 26/03/2025

Accepted: 28/03/2025

### ABSTRACT

The fifth edition of the World Health Organization classification of central nervous system tumors (WHO CNS5) now integrates molecular alterations along with histopathology, emphasizing the crucial role of genetic testing for precise and accurate diagnoses. This development poses significant challenges, particularly in economically disadvantaged countries. ADAPTR group will focus on utilizing histopathology supplemented by basic and surrogate IHC markers.

**Keywords:** World Health Organization, central nervous system tumors, classification

## Dünya Sağlık Örgütü'nün Merkezi Sinir Sistemi Tümörleri Sınıflandırması

### Editorial

#### Süreç

Geliş: 26/03/2025

Kabul: 28/03/2025

#### Telif Hakkı



Bu Çalışma Creative Commons Atıf 4.0 Uluslararası Lisansı Kapsamında Lisanslanmıştır.

### ÖZET

Dünya Sağlık Örgütü'nün merkezi sinir sistemi tümörleri sınıflandırmasının 5. baskısı moleküler değişiklikleri histopatoloji ile birleştirerek doğru ve kesin tanı için genetik testlerin kritik rolünü vurgulamaktadır. Bu durum özellikle ekonomik olarak dezavantajlı ülkelerde zorluklara yol açmaktadır. ADAPTR grubu bu ülkeler için temel histolojik ve immünohistokimyasal belirteçlerle tanının konulabileceğini önermektedir.

**Anahtar Kelimeler:** Dünya Sağlık Örgütü, merkezi sinir sistemi, tümör, sınıflandırma

<sup>a</sup> egilmezreyhan@gmail.com

0000-0001-9666-0246

**How to Cite:** Eğilmez HR. World Health Organization Classification of Central Nervous System Tumors, Cumhuriyet Medical Journal,2025;47(1):1.

## Introduction

The objective of the WHO Classification of Tumors (WHO Blue books) is to provide a uniform nomenclature of human cancers that is accepted and used worldwide. A standardized classification is necessary for pathologists, clinical oncologists and cancer registries. It forms a basis for collecting histologically and genetically stratified and population-base incidence rates and is a prerequisite for comparing cancer therapy trials conducted in different centres and countries.<sup>1</sup>

The fifth edition of the World Health Organization classification of central nervous system tumors (WHO CNS5) now integrates molecular alterations along with histopathology, emphasizing the crucial role of genetic testing for precise and accurate diagnoses. Molecular characteristics identified through next-generation sequencing (NGS) and DNA methylation profiling have become essential diagnostic criteria for certain CNS tumors.<sup>2</sup>

This development poses significant challenges, particularly in economically disadvantaged countries, such as low-income and lower middle-income countries (LICs and LMICs). Following the release of WHO CNS5 in December 2021, the Executive Committee of the Asian Oceanian Society of Neuropathology (AOSNP) recognized an urgent need to facilitate WHO diagnoses in settings

lacking access to molecular testing. To address this, they launched the Asian Oceanian Society of Neuropathology committee for Adapting Diagnostic Approaches for Practical Taxonomy in Resource-Restrained Regions (AOSNP-ADAPTR). This initiative aims to provide a simplified approach for achieving diagnoses in line with WHO CNS5 using relatively basic diagnostic tools, particularly for pathologists in resource-limited regions. The limitation of in-local access to various diagnostic techniques was most significantly noted in LMICs in which many Asian Oceanian countries, the forthcoming recommendations from the ADAPTR group will focus on utilizing histopathology supplemented by basic and surrogate IHC markers. Simpler molecular techniques like FISH and Sanger sequencing will be recommended when necessary for diagnosis.

## References

1. <https://whobluebooks.iarc.fr/about/index.php>
2. Sarkar C, Rao S, Santosh V, Al\_Hussaini M, Hye Park S, Tihan T, Buckland ME, Ng HK, Komori T. Resource availability for CNS tumor diagnostics in the Asian-Oceanian region: A survey by the Asian-Oceanian Society of Neuropathology committee for Adapting Diagnostic Approaches for Practical Taxonomy in Resource-Restrained Regions (AOSNP-ADAPTR). Brain Pathology 2025. <https://doi.org/10.1111/bpa.13329>.



## The Genetics of Sexual Development Disorders

Malik Ejder Yıldırım<sup>1,a,\*</sup>

<sup>1</sup> Sivas Cumhuriyet University, Faculty of Medicine, Department of Medical Genetics, Sivas, Türkiye

\*Corresponding author

### Review

#### History

Received: 21/12/2024

Accepted: 08/03/2025

#### Copyright



This work is licensed under  
Creative Commons Attribution 4.0  
International License

## Cinsel Gelişim Bozukluklarının Genetiği

### Derleme

#### Süreç

Geliş: 21/12/2024

Kabul: 08/03/2025

#### Telif Hakkı



Bu Çalışma Creative Commons Atıf  
4.0 Uluslararası Lisansı  
Kapsamında Lisanslanmıştır.

### ABSTRACT

Sexual development is one of the significant stages of the embryogenesis. In this process, the gonadal differentiation taking place on a genetic basis (sex chromosomes) determines the sexual identity of the individual. Initially, the gonads are considered bipotential because the gonadal primordium can turn into a testicle or ovary through the activation of certain genetic elements in the subsequent period. When there is a disruption at any phase of this period, various clinical conditions called disorders of sexual development (DSD) arise. These conditions, often accompanied by various mutations or sex chromosome abnormalities, may include gonadal dysgenesis and result in a male (46, XY) or female (46, XX) sex reversal. DSD with 46,XY usually contains ambiguous condition, or the presence of female external and/or internal genitalia depending on whether Müllerian tissues are present. On the other hand, different enzyme defects, again, on a genetic basis can lead to disorders of sex development in both males (e.g. 5 $\alpha$ -reductase) and females (e.g. aromatase). Congenital adrenal hyperplasia is a relatively common, autosomal recessive enzyme defect, especially in 46,XX DSD cases. A number of syndromes lead to a certain degree of inadequate sexual development in males or masculinization in females. Patients also have some characteristic physical symptoms accompanied by mental problems. Gonadal dysgenesis can be caused by various mutations, mainly in the SRY gene (e.g. Swyer syndrome) or sex chromosome disorder (Turner syndrome). In cases of 46,XY DSD, mixed gonadal dysgenesis, and some other conditions, prophylactic gonadectomy may be considered because of the malignancy risk.

**Keywords:** Sexual development, mutation, chromosomal abnormality, gonadal dysgenesis, sex reversal.

### ÖZET

Cinsel gelişim embriyogenезin önemli aşamalarından biridir. Bu süreçte, genetik temelde (seks kromozomları) gerçekleşen gonadal farklılaşma bireyin cinsel kimliğini belirler. Başlangıçta gonadlar bipotansiyel olarak kabul edilir çünkü gonadal primordium sonraki dönemde belirli genetik unsurların aktivasyonu ile testis veya overe dönüşebilir. Bu dönemin herhangi bir aşamasında bir aksama olduğunda, cinsel gelişim bozuklukları (DSD) adı verilen çeşitli klinik durumlar ortaya çıkar. Genellikle çeşitli mutasyonlar veya cinsiyet kromozomu anormalliklerinin eşlik ettiği bu koşullara, gonadal disgenezi dahil olabilir ve erkek (46, XY) veya dişi (46, XX) cinsiyet dönüşümü ile sonuçlanabilir. 46,XY DSD genellikle belirsiz bir durumu veya dişi dış ve/veya Müllerian dokuların mevcut olup olmamasına bağlı olarak iç genital organların varlığını içerir. Öte yanda, yine genetik bazda farklı enzim defektleri, hem erkeklerde (örn. 5 $\alpha$ -redüktaz) hem de dişilerde (örn. aromataz) cinsiyet gelişimi bozukluklarına yol açabilmektedir. Konjenital adrenal hiperplazi, özellikle 46,XX DSD olgularında, nispeten sık görülen, otozomal resesif bir enzim defektidir. Bir dizi sendrom, erkeklerde belirli ölçüde yetersiz cinsel gelişime veya dişilerde erkekleşmeye yol açar. Hastalar da, ayrıca mental problemlerin eşliğinde bazı karakteristik fiziksel semptomlar bulunur. Gonadal disgeneziye, başta SRY geni olmak üzere, çeşitli mutasyonlar (örneğin Swyer sendromu) veya cinsiyet kromozom bozukluğu (Turner sendromu) neden olabilir. Netice itibarıyla, 46,XY DSD, karma gonadal disgenezi ve diğer bazı durumlarda, malignite riski nedeniyle profilaktik gonadektomi düşünülebilir.

**Anahtar Kelimeler:** Cinsel gelişim, mutasyon, kromozomal anormallik, gonadal disgenezi, cinsiyet dönüşümü.

<sup>a</sup> mey2002@gmail.com

0000-0003-4386-1583

**How to Cite:** Yıldırım ME. The Genetics of Sexual Development Disorders, Cumhuriyet Medical Journal. 2025; 47(1): 1-8.

## Introduction

Sexual development is an important process that determines the identity, mental health and social position of the individual, independent of physical development. The formation of male and female characteristics in the organism is one of the most important stages of the embryonic period. Gonadal development begins from the 3rd to 4th weeks of embryogenesis, with the emergence of an undifferentiated structure in embryos with XX and XY karyotypes.<sup>1</sup> Initially, gonads are defined as bipotential since the gonadal primordium can differentiate into the testicle or ovary through the activation of some genetic elements during this process.<sup>2</sup> A disruption at any stage of sexual differentiation causes a clinical condition called disorder of sexual development (DSD), and this problem can occur as ovarian, testicular, ovotesticular or complete gonadal dysgenesis. Gonadal dysgenesis can be defined as the termination of gonadal development prior to testicular or ovarian differentiation and may present with chromosomal and phenotypic changes such as Turner syndrome or in the form of pure gonadal dysgenesis without chromosomal abnormalities such as Swyer syndrome.<sup>3</sup> A well-known concept in terms of sexual development disorders is hermaphroditism. True hermaphroditism can be described as the presence of both ovarian and testicular tissue in the same organism with ambiguous genitalia regardless of karyotype,<sup>4</sup> while pseudohermaphroditism is the presence of external genitalia that does not match the karyotype (feminization in males or virilization in females). Hermaphroditism has a multidimensional genetic basis related to different genes. However, to avoid terminological confusion in this article, we use “Disorders of Sexual Development” as a concept, hence DSD as an acronym. Disorders of sexual development can be roughly classified as 46,XY DSD, 46,XX DSD and sex chromosome disorders. DSD with 46,XY involves disorders of testicular development (ovotesticular DSD, complete or partial gonadal dysgenesis, etc.), androgen synthesis-activity disorders (5- $\alpha$ -reductase deficiency, complete or partial androgen insensitivity syndrome, Leydig cell hypoplasia or aplasia), LH and AMH defects, while 46,XX DSD may be a disorder of ovarian development (Ovotesticular DSD, gonadal dysgenesis), congenital adrenal hyperplasia, SRY translocation, placental aromatase deficiency and similar syndromes.<sup>5</sup> Sex chromosome disorders include Turner syndrome, Klinefelter syndrome, and mixed gonadal dysgenesis (45,X/46,XY mosaicism), etc.<sup>6</sup> DSD with 46,XY often involves ambiguous gender, or the presence of female external and/or internal genitalia, depending on whether Müllerian tissues are present.<sup>7</sup> These DSD cases may have phenotypes ranging from fully female external and in some cases internal genitalia to male genitalia with hypospadias, bifid scrotum and undescended testicle.<sup>8</sup> Gonadectomy is recommended for female patients with 46 XY karyotype because of the risk of malignancy and MRI is a more robust and sensitive method than ultrasound to determine the location of the gonads in the preoperative evaluation.<sup>9</sup>

Numerous gene mutations, and enzyme defects on a genetic basis are effective in disorders of sexual development. The relevant gene mutations can cause

phenotypic changes at different levels and can also be involved in the etiology of gonadal dysgenesis. The main genes associated with complete or partial gonadal dysgenesis in the human genome include *SRY*, *SOX9*, *DHH*, *AMH*, *CBX2*, *DMRT1*, *GATA4*, *WNT4*, *WT1*, *MAP3K1*, *DAX1*, *FGFR2*, *FOXL2*, *FGF9*, *NR5A1* and *RSPO1* gene.<sup>10</sup> Furthermore, in terms of 46,XX ovarian dysgenesis, *FSHR*, *BMP15*, *PSMC3IP*, *MCM9*, *SOHLH1*, *NUP107*, *MRPS22* and *ESR2* gene mutations can also lead to such a clinic.<sup>11</sup>

The key element for the development of masculinity is the *SRY* (Sex-determining region Y) gene (Yp11.2). This gene on the short arm of the Y chromosome encodes a transcription factor that triggers male sex development at the 6th week and it is necessary for the activation of *SOX9*, which leads to the differentiation of the Sertoli cells from the somatic precursor cells of the primitive gonad. In this context, the *SRY* protein initiates a genetic cascade that directs testicular differentiation by activating the expression of *SOX9* along with *SF-1*, encoded by the *NR5A1* gene (9q33.3).<sup>12</sup> Activation of *SOX9* expression induces a male-specific process and inhibits ovarian development.<sup>13</sup> *SOX9* (17q24.3) loss-of-function mutations can lead to autosomal sex reversal, gonadal dysgenesis and campomelic dysplasia.<sup>14</sup> Besides *SOX9*, *SRY* also triggers the expression of several other elements that promote masculinity, such as *FGF9* and *PGD2*.<sup>15</sup> Fibroblast growth factor 9 (*FGF9*) is essential for proliferation in a cell population including Sertoli cell precursors in early testicular development and is effective in the nuclear localization of *FGFR2* in precursor Sertoli cells.<sup>16</sup> *FGFR2* is an important marker of testicular differentiation. Nuclear receptor subfamily 5 group A member 1 (*NR5A1*), involved in *SRY* function, is known to be highly expressed in Sertoli and Leydig cells of the gonads, and mutations of the *NR5A1* gene have been identified as the main cause of gonadal dysgenesis in a proportion of 46,XY DSD patients.<sup>17</sup> *SRY* and *SRY*-activated *SOX9* transcription factor and *RSPO1*-*WNT4*- $\beta$ -Catenin signaling serve as antagonistic pathways to direct testicular and ovarian differentiation respectively, from the existing primitive gonad.<sup>18</sup> Inhibition of *WNT*/ $\beta$ -catenin signaling is crucial for fetal testicular development and increased or stimulated *WNT*/ $\beta$ -catenin signaling in testicles causes disruption of seminiferous cord structures, decreased *SOX9*/*AMH* expression, loss of germ cell population, and significant deterioration of Leydig cell function.<sup>19</sup>

Swyer syndrome, a pure gonadal dysgenesis, is a type of DSD characterized by a 46,XY male karyotype and a complete female phenotype and thus sex reversal.<sup>20</sup> This form of complete gonadal dysgenesis should be considered together with the complete absence of masculinization in the external genitalia and the presence of Müllerian tissues, due to testosterone and *AMH* deprivation.<sup>21</sup> The *SRY* gene mutations or deletions come to mind first for this syndrome, and mutations in genes such as *SOX9*, *SF1* and *WT1* can also disrupt *SRY* function. Mutations of *SRY* is found in approximately 15% of females with Swyer syndrome, while mutations of other testicular determinants (*MAP3K1*, *DHH*, *NR5A1* etc.) are responsible for the remainder of cases, independent of the *SRY* gene.<sup>22</sup>



**Table 1.** Mutations and enzyme defects in Disorders of Sexual Development.

46,XY DSD		46,XX DSD	
Mutation	Enzyme defect	Mutation	Enzyme defect
SRY/SOX9	5 $\alpha$ -reductase 2 (SRD5A2)	WNT4	17- $\alpha$ -hydroxylase/ 17,20-lyase (CYP17A1)
NR5A1/FGF9	17- $\alpha$ -hydroxylase/17,20-lyase (CYP17A1)	FOXL2	P450-oxidoreductase (POR)
WT1/DHH	3-beta-hydroxysteroid dehydrogenase (HSD3B2)	RSPO1	21-hydroxylase (CYP21A2)
MAP3K1	P450-oxidoreductase (POR)	FSHR/NR3C1	11- $\beta$ -hydroxylase (CYP11B1)
GATA4		DAX1	Aromatase (CYP19A1)
CBX2/DAX1		BMP15	
FGFR2/DMRT1		MCM9/ESR2	
LHCGR /AR		SOHLH1	
AMH/AMHR		MRPS22	

WNT4, RSPO1 and FOXL2 are among the elements that function in the early ovarian development. These repress male development by restricting SOX9 expression and support female structures by maintaining Müllerian differentiation.<sup>23</sup> The *WNT4* gene (1p.36.1), a member of the WNT family, is involved in female development and the inhibition of testicular formation. Mutations of this gene have been associated with disorders such as Mullerian aplasia, sex reversal, premature ovarian failure and endometriosis.<sup>24</sup> Furthermore, high FGF9 may inhibit WNT4 expression in the embryonic structure, and SRY-negative 46,XX male cases may be associated with a gain in copy numbers of FGF9.<sup>25</sup> In mammals, RSPO1 (R-spondin 1) synergizes with specific Wnt ligands in favor of intracellular  $\beta$ -catenin and in this context, it plays a role in ovarian differentiation.<sup>26</sup> Consequently, in the absence of the *SRY* gene, *WNT4/RSPO1* and beta-catenin pathways present activity for ovarian development, and pathogenic variants of these genes may lead to 46,XX DSD.<sup>27</sup> In addition, *FOXL2* (3q22.3), encoding a forkhead transcription factor, can also arrange early ovarian growth via repressing the expression of testicular genes.<sup>28</sup>

Wilms-tumor 1 (*WT1*), Chromobox 2 (*CBX2*) and NR5A1 are expressed at early stages for undifferentiated gonad and the association of relevant genes with gonadal development has been well documented along with their mutations leading to gonadal dysgenesis.<sup>29</sup> The *WT1* gene (11p13) makes a fundamental contribution to the embryonic development of various systems, such as the urogenital and central nervous system.<sup>30</sup> *WT1* encodes a protein including four zinc fingers involved in urogenital development and pathogenic variants of this gene are linked to abnormalities in testicular development and DSD with 46,XY.<sup>31</sup> *WT1* mutations have been implicated in various syndromes including Denys-Drash syndrome, Frasier syndrome (glomerular nephropathy and complete gonadal dysgenesis with 46,XY karyotype), and WAGR syndrome (Wilms tumor, aniridia, genitourinary malformations, and mental retardation).<sup>32</sup> Denys-Drash syndrome is a rare disorder with pseudohermaphroditism, nephroblastoma (Wilms tumor) and diffuse mesangial

sclerosis and is mostly linked with *WT1* mutations.<sup>33</sup> Frasier syndrome is an inherited disease caused by an intron 9 mutation of the *WT1* gene, presenting with gonadal dysgenesis and progressive nephropathy.<sup>34</sup> On the other hand, *CBX2* is also known to be effective in gonadal differentiation in mammals, and mutations of *CBX2* (17q25.3) can lead to sex reversal.<sup>35</sup> Loss of function in this gene, which is needed for early gonadal development, can be found in 46,XY DSD cases with gonadal dysgenesis and completely female phenotype.<sup>36</sup>

*DMRT1* (9p24.3) is found in a gene family containing a zinc finger-like DNA-binding motif. Deletions of chromosome 9p involving *DMRT1* can cause 46,XY sex reversal in humans and are associated with the formation of gonadoblastoma.<sup>37</sup> Point mutations and deletions of *DMRT1* have also been linked to the 46,XY complete gonadal dysgenesis.<sup>38</sup>

The protein encoded by *DHH* gene (12q13.1), a member of the Hedgehog gene family, is clearly expressed in Sertoli cells and it can regulate testicular development and spermatogenesis, in addition, this gene may be necessary for the differentiation of Leydig cells.<sup>39</sup> *DHH* is involved in the interaction between Sertoli cells and germ cells, and *DHH* gene mutations may be responsible for male infertility and gonadal dysgenesis.<sup>40</sup>

Although the *GATA4* gene (8p23.1) is known to cause congenital heart disease, its mutations are now also thought to be linked to disorders of sexual development (46,XY DSD).<sup>41</sup> A transcription factor encoded by this gene interacts with certain proteins, such as NR5A1, WT1 to regulate the expression of SRY, SOX9 and AMH etc., and its function appears to be essential for testicular development.<sup>42</sup>

*MAP3K1* (5q11.2), which is a signal transduction gene, is a member of the gene network involved in gonadal development.<sup>43</sup> *MAP3K1* gain-of-function mutations disrupt the balance by increasing *WNT*/beta-catenin/*FOXL2* expression and decreasing *SOX9/FGF9/FGFR2/SRY* expression in 46,XY karyotype and are therefore responsible for a proportion of 46,XY DSD cases.<sup>44</sup>

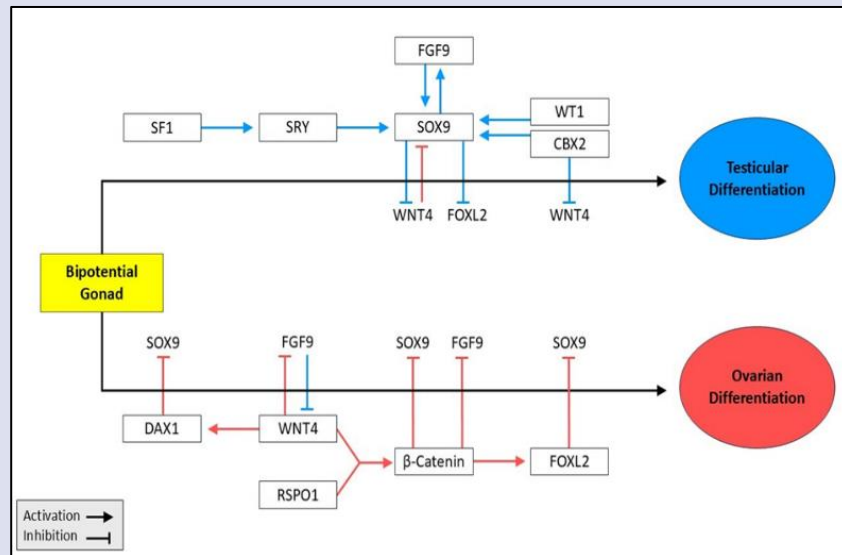

Figure 1. Genes of the gonadal differentiation pathway.

Table 2. DSD-related receptor defects

Receptor (46,XX DSD)	Clinical status	Inheritance
FSHR	Ovarian dysgenesis / Ovarian hyperstimulation syndrome	AR / AD
NR3C1	Glucocorticoid resistance / Hypertension / Hyperandrogenism	AD
ESR2	Ovarian dysgenesis	AD
DAX1	Hypogonadotropic hypogonadism	XL
Receptor (46,XY DSD)	Clinical status	Inheritance
AR	Androgen insensitivity, Spinal and bulbar muscular atrophy	XLR
LHCGR	Leydig cell hypoplasia with hypergonadotropic hypogonadism, pseudohermaphroditism	AR
AMHR	Persistent Mullerian duct syndrome	AR
FGFR2	Craniosynostosis / 46,XY DSD	AD
DAX1	46,XY Sex-reversal / Con. adrenal hypoplasia	XL

DAX1 is a nuclear receptor protein encoded by the *DAX1* gene (Xp21.2) and has a role in the development of hypothalamo-pituitary axis, gonadal and adrenal tissues.<sup>45</sup> Congenital adrenal hypoplasia with X-linked inheritance is a rare disorder resulting from mutations in the *DAX1* gene (NR0B1) and manifests as adrenal insufficiency in infancy and later pubertal failure based on hypogonadotropic hypogonadism.<sup>46</sup> On the other hand, duplications of *DAX1* gene in cases with XY karyotype can lead to male-to-female sex reversal, gonadal dysgenesis, or more precisely, DSD known as dosage-sensitive sex reversal (DSS).<sup>47</sup>

The main function of Leydig cells, as interstitial cells located near the seminiferous tubules, is to produce testosterone under the influence of luteinizing hormone (LH).<sup>48</sup> Testosterone produced by Leydig cells is crucial in the development of the male phenotype, as it causes the Wolffian ducts to differentiate into male genitalia.<sup>49</sup> Leydig cell hypoplasia can be defined as a disorder of sexual development (46,XY DSD) caused by a mutation in the luteinizing hormone/chorionic gonadotropin hormone receptor (LHCGR).<sup>50</sup> It is a type of disease in which the female phenotype predominates, but is characterized by primary amenorrhea and the presence of

testicular tissue.<sup>51</sup> Another receptor dysfunction is primary glucocorticoid resistance caused by mutations in the glucocorticoid receptor gene, *NR3C1* (5q31.3), and may result in phenotypic changes from androgen excess in cases with 46,XX normal ovarian development due to ACTH overproduction.<sup>27</sup>

Anti-Müllerian Hormone (AMH) is a structure secreted by Sertoli cells and is involved in the regression of Müllerian ducts as an element of the sexual differentiation period in males.<sup>52</sup> *AMH* (19p13.3) or *AMHR*, AMH receptor gene (12q13.1) mutations are associated with the development of a persistent Müllerian duct syndrome, and such patients with male genotype and phenotype have female internal organs (upper vagina, cervix, uterus and oviducts) from a lack of anti-Müllerian hormone or insensitivity of tissues to anti-Müllerian hormone.<sup>53</sup>

Androgen insensitivity syndrome (AIS), known as one of the most common disorders of sexual development (DSD) in cases with 46XY karyotype, is an X-linked recessive disease caused by mutations in the androgen receptor (*AR*) gene (Xq12).<sup>54</sup> It can be described as a disorder that occurs due to complete or partial resistance to the effects of androgens in XY males despite a normal testicular structure and proper androgen production.<sup>55</sup> As

a nuclear receptor, AR enables cells in different tissues to respond to testosterone derivatives and AIS occurs through phenotypic expression of *AR* gene defects.<sup>56</sup> The phenotype of the disease varies from all female external genitalia in the complete form (CAIS), to underdeveloped male external genitalia in the partial form (PAIS), and even normal male external genitalia in the mild form (MAIS) manifested by infertility and/or gynecomastia.<sup>57</sup>

Another important issue regarding the problems of sexual development is sex chromosome disorders. Turner syndrome, also called monosomy X (45,X) in females, is a disease characterized by hypergonadotropic hypogonadism, short stature, low hairline, webbed neck, low-set ears, micrognathia, lymphedema of the hands and feet, and cardiac defects, and in most cases a streak gonad is likely to be encountered. The phenotype of Turner syndrome can also result from structural X chromosome abnormalities such as Xp or Xq deletion, isochromosome, 46,X,i(X), or ring chromosome, 46,X,r(X).<sup>58</sup> The short stature in Turner syndrome is very likely to be related to loss of the *SHOX* gene (Xp22.3), i.e. haploinsufficiency. Klinefelter syndrome, with a karyotype of 47,XXY is characterized by small testicles, delayed puberty, tall stature, gynecomastia and poor body hair growth, and infertility is often present.

A rare condition among 46,XX DSD cases is 46 XX male syndrome, also known as De la Chapelle syndrome, in which an individual has a male phenotype despite the 46,XX karyotype.<sup>59</sup> It is accepted that an abnormal change known as a translocation between the X-Y chromosomes may occur during sperm meiosis and leads to offspring with 46,XX male phenotype carrying the *SRY* gene as a result of fertilization, but upregulation of *SOX9* expression because of chromosomal abnormalities or various mutations can also cause a similar phenotype without the *SRY* gene.<sup>60</sup>

On the other hand, there are a number of multisystemic syndromes that can be accompanied by disorders of sexual development. These include Kallmann syndrome, characterized by hypogonadotropic hypogonadism and olfactory dysfunction; McCune-Albright syndrome, described as fibrous dysplasia of bone with café-au-lait spots, and precocious puberty<sup>61</sup>; and Prader Willi syndrome, which results from paternal chromosome 15 deletion and presents with hypotonia, obesity, cognitive impairments, and hypogonadism. While McCune-Albright syndrome is caused by *GNAS* (20q13) gene mutations, multiple genes are responsible for Kallman syndrome. Prader Willi syndrome most often occurs with a deletion of paternal 15. chromosome, although less commonly patients may inherit both chromosomes 15 from the mother (maternal uniparental disomy).

Although certain gene mutations are reflected directly in the phenotype, some enzyme defects in the genetic background also lead to disorders of sexual development. In this regard, one of the relatively common enzyme disorders is congenital adrenal hyperplasia (CAH). The concept of congenital adrenal hyperplasia refers a group

of autosomal recessive diseases arising from defects in the adrenal steroidogenic pathway due to diverse enzyme deficiencies.<sup>62</sup> The most prevalent type is 21-hydroxylase deficiency, resulting from mutations in the *CYP21A2* gene (6p21), while less common cases comprise 3 $\beta$ -hydroxysteroid dehydrogenase and 11 $\beta$ -hydroxylase deficiencies due to mutations in the *HSD3B2* (1p12) and *CYP11B1* (8q24) genes, respectively.<sup>63</sup> 21-Hydroxylase deficiency may lead to hyponatremia, hyperkalemia, dehydration in patients and ambiguous genitalia in females. Children with 3 $\beta$ -HSD deficiency often suffer from adrenal insufficiency and salt loss, and in male infants, masculinization of the external genitalia is impaired to varying degrees (Pseudohermaphroditism).<sup>64</sup> Congenital adrenal hyperplasia resulting from 11 $\beta$ -Hydroxylase deficiency may present with hypertension, hypokalemia, short stature, as well as virilization in females (DSD) on the basis of increased adrenal androgens.<sup>65</sup> CAH accompanied by genital virilization is the most common cause of 46,XX DSD cases. CAH mostly occurs because of the 21-hydroxylase defect, resulting in impaired cortisol production and this causes overproduction of hormonal precursors and then conversion into androgens.<sup>66</sup> In addition, congenital adrenal hyperplasia (CAH) can rarely be caused by 17  $\alpha$ -hydroxylase deficiency and/or 17,20 lyase deficiency on the basis of *CYP17A1* gene mutations.<sup>67</sup> In this disease, the synthesis of cortisol and sex steroids decreases, and mineralocorticoid precursors increase, and therefore 46,XX or 46,XY DSD, hypertension and hypokalemia occur.<sup>68</sup> On the other hand, cytochrome P450 oxidoreductase deficiency (*POR* gene, 7q11.23) -a congenital adrenal hyperplasia subsequently identified-has a steroid nature suggesting impairment in both 17 $\alpha$ -hydroxylase/17,20-lyase and 21-hydroxylase activity.<sup>69</sup> It is a steroidogenesis disorder with a wide phenotypic manifestation encompassing cortisol deficiency (usually partial), changes in the synthesis of sex steroids, disorders of sexual development (DSD), and some skeletal malformations.<sup>70</sup>

One of the enzyme defects involved in sexual development disorders is aromatase deficiency. This disease rarely occurs as a result of loss-of-function mutations in the *CYP19A1* gene (15q21.2).<sup>71</sup> Since cytochrome P450 aromatase is involved in estrogen synthesis from androgens and prevents the virilizing effect of androgens in the female fetus, aromatase deficiency should be kept in mind in terms of 46,XX DSD.<sup>72</sup> The main problem here is the masculinization of the female, and such infants usually have ambiguous genitalia. Patients have decreased estrogen and increased testosterone and are likely to experience ovarian cysts and hirsutism.

Another enzyme defect, called 5 $\alpha$ -reductase type 2 (5 $\alpha$ -RD2) deficiency, leads to a 46,XY disorder of sex development and occurs as a result of *SRD5A2* (2p23.1) mutations.<sup>73</sup> This disease is inherited in an autosomal recessive pattern. The steroid 5 $\alpha$ -reductase type 2 enables the conversion of testosterone to dihydrotestosterone,<sup>74</sup> and respectively one is involved in

the transformation of Wolffian ducts into male internal genitalia, while the other, a more active form, is particularly vital for the development of male external genitalia.<sup>75</sup> The main problem of these patients is dihydrotestosterone deficiency. These cases have dysmorphological features ranging from nearly female external genitalia to underdeveloped male genitalia. Most patients present as male pseudohermaphroditism and can be bred as female. A certain amount of virilization may occur over time.

In conclusion, the genetics of DSD with various mutations, including enzyme defects, are complex and require careful approach in terms of diagnosis, treatment, follow-up, and genetic counseling for subsequent generations. The relevant genetic defect may originate from the parent's germ cells or arise during embryogenesis. It is possible that gene therapy will come into play in the near future, alongside classical medical interventions and surgery. DSDs affect people's psychological and social life, mental development and even personality in some way. If untreated and/or psychological support is not provided, it is likely that depression, anxiety, bipolar disorder, etc. may be seen in these people based on the sexual development disorder. Therefore, in addition to surgical and medical treatment, these patients should receive psychiatric and/or psychological support as needed.

## References

- Lamothe S, Bernard V, Christin-Maitre S. Gonad differentiation toward ovary. *Ann Endocrinol (Paris)*. 2020;81(2-3):83-88.
- Vivanco E, Goles E, Montalva-Medel M, Poupin MJ. Dynamical robustness of a Boolean model for the human gonadal sex determination. *Comput Biol Chem*. 2024;113:108225.
- Ación P, Ación M. Disorders of Sex Development: Classification, Review, and Impact on Fertility. *J Clin Med*. 2020;9(11):3555.
- Kim KR, Kwon Y, Joung JY, Kim KS, Ayala AG, Ro JY. True hermaphroditism and mixed gonadal dysgenesis in young children: a clinicopathologic study of 10 cases. *Mod Pathol*. 2002;15(10):1013-9.
- Allen L. Disorders of sexual development. *Obstet Gynecol Clin North Am*. 2009;36(1):25-45.
- García-Acero M, Moreno O, Suárez F, Rojas A. Disorders of Sexual Development: Current Status and Progress in the Diagnostic Approach. *Curr Urol*. 2020;13(4):169-178.
- Davies K. The XY Female: Exploring Care for Adolescent Girls with Complete Androgen Insensitivity Syndrome. *Compr Child Adolesc Nurs*. 2020;43(4):378-88.
- Massanyi EZ, Dicarolo HN, Migeon CJ, Gearhart JP. Review and management of 46,XY disorders of sex development. *J Pediatr Urol*. 2013;9(3):368-79.
- Basri NI, Soon CH, Ali A, Abdul Ghani NA, Zainuddin AA. Prophylactic gonadectomy in 46 XY females; why, where and when? *Horm Mol Biol Clin Investig*. 2021;42(3):325-8.
- Luppino G, Wasniewska M, Coco R, Pepe G, Morabito LA, Li Pomi A, et al. Role of NR5A1 Gene Mutations in Disorders of Sex Development: Molecular and Clinical Features. *Curr Issues Mol Biol*. 2024;46(5):4519-32.
- Alkhzouz C, Bucerzan S, Miclaus M, Mirea AM, Miclea D. 46,XX DSD: Developmental, Clinical and Genetic Aspects. *Diagnostics (Basel)*. 2021;11(8):1379.
- Sreenivasan R, Gonen N, Sinclair A. SOX Genes and Their Role in Disorders of Sex Development. *Sex Dev*. 2022;16(2-3):80-91.
- Racca JD, Chen YS, Brabender AR, Battistin U, Weiss MA, Georgiadis MM. Role of nucleobase-specific interactions in binding and bending of DNA by human male sex-determination factor SRY. *J Biol Chem*. 2024:107683. doi: 10.1016/j.jbc.2024.107683.
- Witchel SF. Disorders of sex development. *Best Pract Res Clin Obstet Gynaecol*. 2018;48:90-102.
- Harpelunde Poulsen K, Nielsen JE, Frederiksen H, Melau C, Juul Hare K, Langhoff Thuesen L, et al. Dysregulation of FGFR signalling by a selective inhibitor reduces germ cell survival in human fetal gonads of both sexes and alters the somatic niche in fetal testes. *Hum Reprod*. 2019;34(11):2228-43.
- Schmahl J, Kim Y, Colvin JS, Ornitz DM, Capel B. Fgf9 induces proliferation and nuclear localization of FGFR2 in Sertoli precursors during male sex determination. *Development*. 2004;131(15):3627-36.
- Alhamoudi KM, Alghamdi B, Aljomaiah A, Alswailem M, Al-Hindi H, Alzahrani AS. Case Report: Severe Gonadal Dysgenesis Causing 46,XY Disorder of Sex Development Due to a Novel NR5A1 Variant. *Front Genet*. 2022;13:885589.
- Tang F, Richardson N, Albina A, Chaboissier M-C, Perea-Gomez A. Mouse Gonad Development in the Absence of the Pro-Ovary Factor WNT4 and the Pro-Testis Factor SOX9 Cells. 2020;9(5):1103.
- Lundgaard Riis M, Delpouve G, Nielsen JE, Melau C, Langhoff Thuesen L, Juul Hare K, et al. Inhibition of WNT/beta-catenin signalling during sex-specific gonadal differentiation is essential for normal human fetal testis development. *Cell Commun Signal*. 2024;22(1):330.
- Sowińska-Przepiera E, Krzyściński M, Przepiera A, Brodowska A, Malanowska E, Kozłowski M, et al. Late Diagnosis of Swyer Syndrome in a Patient with Bilateral Germ Cell Tumor Treated with a Contraceptive Due to Primary Amenorrhea. *Int J Environ Res Public Health*. 2023;20(3):2139.
- Tarenia SS, Chattopadhyay S, Das N, Hathi D, Baidya A, Chakrabarty P, et al. Swyer Syndrome Presenting as Dysgerminoma: A Case Report. *J ASEAN Fed Endocr Soc*. 2023;38(1):108-13.
- Winkler I, Jaszczuk I, Gogacz M, Szkodziak P, Paszkowski T, Skorupska K, et al. A Successful New Case of Twin Pregnancy in a Patient with Swyer Syndrome-An Up-to-Date Review on the Incidence and Outcome of Twin/Multiple Gestations in the Pure 46,XY Gonadal Dysgenesis. *Int J Environ Res Public Health*. 2022;19(9):5027.
- Biason-Lauber A. WNT4, RSPO1, and FOXL2 in sex development. *Semin Reprod Med*. 2012;30(5):387-95.
- Ragitha TS, Sunish KS, Gilvaz S, Daniel S, Varghese PR, Raj S, et al. Mutation analysis of WNT4 gene in SRY negative 46,XX DSD patients with Mullerian agenesis and/or gonadal dysgenesis- An Indian study. *Gene*. 2023;861:147236.
- Chiang HS, Wu YN, Wu CC, Hwang JL. Cytogenic and molecular analyses of 46,XX male syndrome with clinical comparison to other groups with testicular azoospermia of genetic origin. *J Formos Med Assoc*. 2013;112(2):72-8.
- Zhou L, Charkraborty T, Zhou Q, Mohapatra S, Nagahama Y, Zhang Y. Rspo1-activated signalling molecules are sufficient

- to induce ovarian differentiation in XY medaka (*Oryzias latipes*). *Sci Rep.* 2016;6:19543.
27. Abali ZY, Guran T. Diagnosis and management of non-CAH 46,XX disorders/differences in sex development. *Front Endocrinol (Lausanne).* 2024;15:1354759.
  28. Xie Y, Wu C, Li Z, Wu Z, Hong L. Early Gonadal Development and Sex Determination in Mammal. *Int J Mol Sci.* 2022;23(14):7500.
  29. Holterhus PM, Kulle A, Busch H, Spielmann M. Classic genetic and hormonal switches during fetal sex development and beyond. *Med Genet.* 2023;35(3):163-71.
  30. Huang YC, Tsai MC, Tsai CR, Fu LS. Frasier Syndrome: A Rare Cause of Refractory Steroid-Resistant Nephrotic Syndrome. *Children (Basel).* 2021;8(8):617.
  31. Gomes NL, de Paula LCP, Silva JM, Silva TE, Lerário AM, Nishi MY, et al. A 46,XX testicular disorder of sex development caused by a Wilms' tumour Factor-1 (WT1) pathogenic variant. *Clin Genet.* 2019;95(1):172-6.
  32. Lopez-Gonzalez M, Ariceta G. WT1-related disorders: more than Denys-Drash syndrome. *Pediatr Nephrol.* 2024;39(9):2601-9.
  33. Li T, Zhou J, Wu H, Gao X, Shen Q, Cheng R, et al. Single-cell transcriptomes of kidneys in a 6-month-old boy with Denys-Drash syndrome reveal stromal cell heterogeneity in the tumor microenvironment. *Clin Kidney J.* 2023;17(1):sfad277.
  34. Shao Q, Xie X, Geng J, Yang X, Li W, Zhang Y. Frasier Syndrome: A 15-Year-Old Phenotypically Female Adolescent Presenting with Delayed Puberty and Nephropathy. *Children (Basel).* 2023;10(3):577.
  35. Hart D, Rodríguez Gutiérrez D, Biason-Lauber A. CBX2 in DSD: The Quirky Kid on the Block. *Sex Dev.* 2022;16(2-3):162-70.
  36. Ohnesorg T, Vilain E, Sinclair AH. The genetics of disorders of sex development in humans. *Sex Dev.* 2014;8(5):262-72.
  37. Koster R, Mitra N, D'Andrea K, Vardhanabhuti S, Chung CC, Wang Z, et al. Pathway-based analysis of GWAs data identifies association of sex determination genes with susceptibility to testicular germ cell tumors. *Hum Mol Genet.* 2014;23(22):6061-8.
  38. Zarkower D, Murphy MW. DMRT1: An Ancient Sexual Regulator Required for Human Gonadogenesis. *Sex Dev.* 2022;16(2-3):112-25.
  39. Wei J, Wu J, Ru W, Chen G, Gao L, Tang D. Novel compound heterozygous mutations in the desert hedgehog (DHH) gene in cases of siblings with 46,XY disorders of sexual development. *BMC Med Genomics.* 2022;15(1):178.
  40. Mehta P, Singh P, Gupta NJ, Sankhwar SN, Chakravarty B, Thangaraj K, et al. Mutations in the desert hedgehog (DHH) gene in the disorders of sexual differentiation and male infertility. *J Assist Reprod Genet.* 2021;38(7):1871-78.
  41. Shichiri Y, Kato Y, Inagaki H, Kato T, Ishihara N, Miyata M, et al. A case of 46,XY disorders of sex development with congenital heart disease caused by a GATA4 variant. *Congenit Anom (Kyoto).* 2022;62(5):203-7.
  42. Martínez de LaPiscina I, de Mingo C, Riedl S, Rodríguez A, Pandey AV, Fernández-Cancio M, et al. GATA4 Variants in Individuals With a 46,XY Disorder of Sex Development (DSD) May or May Not Be Associated With Cardiac Defects Depending on Second Hits in Other DSD Genes. *Front Endocrinol (Lausanne).* 2018;9:142.
  43. Granados A, Alaniz VI, Mohnach L, Barseghyan H, Vilain E, Ostrer H, et al. MAP3K1-related gonadal dysgenesis: Six new cases and review of the literature. *Am J Med Genet C Semin Med Genet.* 2017;175(2):253-9.
  44. King TFJ, Conway GS. Swyer syndrome. *Curr Opin Endocrinol Diabetes Obes.* 2014;21(6):504-10.
  45. Nagel SA, Hartmann MF, Riepe FG, Wudy SA, Wabitsch M. Gonadotropin- and Adrenocorticotropic Hormone-Independent Precocious Puberty of Gonadal Origin in a Patient with Adrenal Hypoplasia Congenita Due to DAX1 Gene Mutation - A Case Report and Review of the Literature: Implications for the Pathomechanism. *Horm Res Paediatr.* 2019;91(5):336-45.
  46. Landau Z, Hanukoglu A, Sack J, Goldstein N, Weintrob N, Eliakim A, et al. Clinical and genetic heterogeneity of congenital adrenal hypoplasia due to NR0B1 gene mutations. *Clin Endocrinol (Oxf).* 2010;72(4):448-54.
  47. Ludbrook LM, Harley VR. Sex determination: a 'window' of DAX1 activity. *Trends Endocrinol Metab.* 2004;15(3):116-21.
  48. Vasta V, Shimizu-Albergine M, Beavo JA. Modulation of Leydig cell function by cyclic nucleotide phosphodiesterase 8A. *PNAS U S A.* 2006;103(52):19925-30.
  49. Habert R, Lejeune H, Saez JM. Origin, differentiation and regulation of fetal and adult Leydig cells. *Mol Cell Endocrinol.* 2001;179(1-2):47-74.
  50. Hassan HA, Essawi ML, Mekkawy MK, Mazen I. Novel mutations of the LHCGR gene in two families with 46,XY DSD causing Leydig cell hypoplasia I. *Hormones (Athens).* 2020;19(4):573-9.
  51. Çömlek FÖ, Yıldız R, Seyrek F, Tütüncüler F. Leydig cell hypoplasia type 1 diagnosed in early childhood with inactivating mutation in LHCGR gene. *Oxf Med Case Reports.* 2021;4,153-5
  52. Benderradji H, Prasivoravong J, Marcelli F, Leroy C. Role of Anti-Mullerian Hormone in Male Reproduction and Sperm Motility. *Semin Reprod Med.* 2024;42(1):5-14.
  53. Alshwayyat S, Hanifa H, M Amro A, Shlool N, Alfaqeh Q, Alloush A. Persistent Mullerian duct syndrome in a male child: A rare case report on the intersection of surgical importance and economic barriers in Syria. *Int J Surg Case Rep.* 2024;123:110315.
  54. Delli Paoli E, Di Chiano S, Paoli D, Lenzi A, Lombardo F, Pallotti F. Androgen insensitivity syndrome: a review. *J Endocrinol Invest.* 2023;46(11):2237-45.
  55. Hughes IA, Davies JD, Bunch TI, Pasterski V, Mastroyannopoulou K, MacDougall J. Androgen insensitivity syndrome. *Lancet.* 2012;380(9851):1419-28.
  56. Gulía C, Baldassarra S, Zangari A, Briganti V, Gigli S, Gaffi M, et al. Androgen insensitivity syndrome. *Eur Rev Med Pharmacol Sci.* 2018;22(12):3873-87.
  57. Batista RL, Costa EMF, Rodrigues AS, Gomes NL, Faria JA Jr, Nishi MY, et al. Androgen insensitivity syndrome: a review. *Arch Endocrinol Metab.* 2018;62(2):227-35.
  58. Ibarra-Ramírez M, Campos-Acevedo LD, Martínez de Villarreal LE. Chromosomal Abnormalities of Interest in Turner Syndrome: An Update. *J Pediatr Genet.* 2023;12(4):263-72.
  59. Hosseini J, Zamani Hajiabadi A, Mirjalili AM. Ventral-Onlay Buccal Mucosal Graft Urethroplasty of a Perineal Fistula in a 26-Year-Old Patient With 46 XX Male Syndrome: A Case Report. *Am J Mens Health.* 2023;17(2):1-4.
  60. Wang T, Liu JH, Yang J, Chen J, Ye ZQ. 46, XX male sex reversal syndrome: a case report and review of the genetic basis. *Andrologia.* 2009;41(1):59-62.
  61. Javid MK, Boyce A, Appelman-Dijkstra N, Ong J, Defabianis P, Offiah A, et al. Best practice management guidelines for fibrous dysplasia/McCune-Albright syndrome: a consensus statement from the

- FD/MAS international consortium. *Orphanet J Rare Dis.* 2019;14(1):139.
62. Auer MK, Nordenström A, Lajic S, Reisch N. Congenital adrenal hyperplasia. *Lancet.* 2023;401(10372):227-44.
  63. Witchel SF. Congenital Adrenal Hyperplasia. *J Pediatr Adolesc Gynecol.* 2017;30(5):520-34.
  64. Chen L, Huang H, Zhang H, Zhu G, Zhu M. Three cases of 3beta-hydroxysteroid dehydrogenase deficiency: Clinical analysis. *Adv Clin Exp Med.* 2021;30(3):289-99.
  65. Bulsari K, Falhammar H. Clinical perspectives in congenital adrenal hyperplasia due to 11beta-hydroxylase deficiency. *Endocrine.* 2017;55(1):19-36.
  66. Gardner M, Khorashad BS, Lee PA, Kogan BA, Sandberg DE. Recommendations for 46,XX Congenital Adrenal Hyperplasia Across Two Decades: Insights from the North American Differences of Sex Development Clinician Survey. *Arch Sex Behav.* 2024;53(5):1695-711.
  67. Asirvatham AR, Balachandran K, Jerome P, Venkatesan V, Koshy T, Mahadevan S. Clinical, biochemical and genetic characteristics of children with congenital adrenal hyperplasia due to 17 $\alpha$ -hydroxylase deficiency. *J Pediatr Endocrinol Metab* 2020; 33(8): 1051–56.
  68. Siklar Z, Camtosun E, Bolu S, Yildiz M, Akinci A, Bas F et al. 17 $\alpha$  Hydroxylase/17,20 lyase deficiency: clinical features and genetic insights from a large Turkey cohort. *Endocrine* (2024) 85:1407–16.
  69. Flück CE, Miller WL. P450 oxidoreductase deficiency: a new form of congenital adrenal hyperplasia. *Curr Opin Pediatr.* 2006;18(4):435-41.
  70. Idkowiak J, Cragun D, Hopkin RJ, Arlt W. Cytochrome P450 Oxidoreductase Deficiency. *GeneReviews*<sup>®</sup> [Internet]. Free Books & Documents. 2005 [updated 2017].
  71. Li H, Fu S, Dai R, Sheng Z, Liu W. Aromatase deficiency caused by mutation of CYP19A1 gene: A case report. *Zhong Nan Da Xue Xue Bao Yi Xue Ban.* 2022;47(6):794-800.
  72. Belgorosky A, Guercio G, Pepe C, Saraco N, Rivarola MA. Genetic and clinical spectrum of aromatase deficiency in infancy, childhood and adolescence. *Horm Res.* 2009;72(6):321-30.
  73. Zhang W, Yu B, Luo W, Sun B, Zhang X, Wang X, et al. In vitro functional study of fifteen SRD5A2 variants found in Chinese patients and the relation between the SRD5A2 genotypes and phenotypes. *J Steroid Biochem Mol Biol.* 2023;235:106421.
  74. Cheon CK. Practical approach to steroid 5alpha-reductase type 2 deficiency. *Eur J Pediatr.* 2011;170(1):1-8.
  75. Gui T, Yao F, Yang X, Wang X, Nie M, Wu X, Tian Q. Genotype-Phenotype Correlation Analysis and Identification of a Novel SRD5A2 Mutation in Four Unrelated Chinese Patients with 5alpha-Reductase Deficiency. *Int J Gen Med.* 2022;15:6633-43.



## Artificial Intelligence in HIV Diagnosis and Treatment: A Comprehensive Review

Bahar Şenel<sup>1,a,\*</sup>, Hayati Beka<sup>2,b</sup>

<sup>1</sup> Department of Medical Microbiology, Istanbul Faculty of Medicine, Istanbul University, Istanbul, Türkiye

<sup>2</sup> Department of Medical Microbiology, Faculty of Medicine, Istanbul Arel University, Istanbul, Türkiye

\*Corresponding author

### Systematic Review

History

Received: 31/01/2025

Accepted: 18/03/2025

Copyright



This work is licensed under  
Creative Commons Attribution 4.0  
International License

### ABSTRACT

**Objective:** This review examines the applications of Artificial Intelligence (AI) in HIV diagnosis, treatment optimization, and epidemiological modeling. It explores how AI enhances early detection, personalizes antiretroviral therapy (ART), and supports public health strategies while addressing ethical and accessibility challenges.

**Methods:** A systematic literature search was conducted in PubMed, Scopus, and Web of Science for peer-reviewed studies published between 2010 and 2024. Relevant policy documents from WHO and UNAIDS were also reviewed. Studies on AI applications in HIV diagnosis, treatment, and epidemiology were included, while non-peer-reviewed, non-English, and unrelated studies were excluded. Selected studies were categorized into key thematic areas.

**Results:** Machine Learning (ML) techniques, particularly supervised models like support vector machines (SVM) and random forests (RF), have significantly improved HIV diagnosis by enhancing accuracy in early detection. Deep Learning (DL)-assisted drug discovery methods, such as generative adversarial networks (GANs), have accelerated ART regimen development. Epidemiological modeling has benefited from AI's ability to analyze large datasets, informing targeted interventions. However, challenges such as algorithmic biases, data privacy concerns, and limited AI adoption in low-resource settings remain barriers to implementation.

**Conclusion:** AI has transformed HIV management by improving diagnosis, treatment, and epidemic control. Future research should focus on refining AI models, increasing data inclusivity, and ensuring ethical and equitable AI integration into global healthcare systems to maximize its impact.

**Keywords:** Artificial Intelligence, HIV Diagnosis and Treatment, Machine Learning, Deep Learning, Neural Networks, Epidemiological Modeling, Antiretroviral Therapy (ART)

## HIV Tanı ve Tedavisinde Yapay Zeka: Kapsamlı Bir Derleme

### Sistematik Derleme

Süreç

Geliş: 31/01/2025

Kabul: 18/03/2025

Telif Hakkı



Bu Çalışma Creative Commons Atfı  
4.0 Uluslararası Lisansı  
Kapsamında Lisanslanmıştır.

### ÖZET

**Amaç:** Bu derleme, Yapay Zekâ'nın (YZ) HIV tanısı, tedavi optimizasyonu ve epidemiyolojik modellemedeki uygulamalarını incelemektedir. YZ'nin erken teşhisi nasıl geliştirdiği, antiretroviral tedaviyi (ART) nasıl kişiselleştirdiği ve halk sağlığı stratejilerini nasıl desteklediği ele alınırken etik ve erişilebilirlik zorlukları da tartışılmaktadır.

**Yöntem:** 2010-2024 yılları arasında yayımlanan hakemli çalışmaları içeren sistematik bir literatür taraması PubMed, Scopus ve Web of Science veritabanlarında gerçekleştirilmiştir. Ayrıca, Dünya Sağlık Örgütü (WHO) ve UNAIDS'in ilgili politika belgeleri incelenmiştir. HIV tanısı, tedavisi ve epidemiyolojisinde YZ uygulamalarına odaklanan çalışmalar dâhil edilirken, hakemli olmayan, İngilizce dışındaki dillerde yayımlanmış ve konu ile ilgisiz çalışmalar hariç tutulmuştur. Seçilen çalışmalar, temel tematik alanlara göre sınıflandırılmıştır.

**Bulgular:** Makine Öğrenimi (ML) teknikleri, özellikle destek vektör makineleri (SVM) ve rastgele ormanlar (RF) gibi denetimli modeller, HIV teşhisinde erken tespit doğruluğunu artırarak önemli gelişmeler sağlamıştır. Derin Öğrenme (DL) destekli ilaç keşif yöntemleri, özellikle üretici çekişmeli ağlar (GANs), ART (antiretroviral tedavi) rejimi geliştirme sürecini hızlandırmıştır. Epidemiyolojik modelleme, AI'nin büyük veri setlerini analiz etme yeteneğinden faydalanarak hedefe yönelik müdahaleleri şekillendirmeye yardımcı olmuştur. Ancak, algoritmik önyargılar, veri gizliliği endişeleri ve düşük kaynaklı bölgelerde AI'nin sınırlı benimsenmesi gibi zorluklar, uygulamada engeller oluşturmaya devam etmektedir.

**Sonuç:** YZ, HIV yönetimini tanı, tedavi ve salgın kontrolü açısından dönüştürmüştür. Gelecekteki araştırmalar, YZ modellerinin iyileştirilmesine, veri kapsayıcılığının artırılmasına ve etik ile eşitlik ilkelerine uygun bir şekilde küresel sağlık sistemlerine entegrasyonunun sağlanmasına odaklanmalıdır.

**Anahtar Kelimeler:** Yapay Zekâ, HIV Tanısı, HIV Tedavisi, Makine Öğrenimi, Derin Öğrenme, Sinir Ağları, Epidemiyolojik Modelleme, Antiretroviral Tedavi (ART).

<sup>a</sup> baharkarli@gmail.com

<sup>ID</sup> 0000-0002-9175-6107

<sup>b</sup> hayatibeka@gmail.com

<sup>ID</sup> 0000-0002-5509-0248

**How to Cite:** Senel B, Beka H. Artificial Intelligence in HIV Diagnosis and Treatment: A Comprehensive Review, Cumhuriyet Medical Journal. 2025,47(1): 10-21.

## Introduction

HIV remains a significant global public health challenge, with an estimated 38 million people living with HIV worldwide as of 2023. Despite advancements in ART, which has transformed HIV from a fatal disease into a manageable chronic condition, substantial gaps persist in early diagnosis, treatment optimization, and epidemic control, especially in low-resource settings.<sup>1,2</sup>

Artificial Intelligence (AI) has emerged as a transformative force across various fields, including healthcare. AI is a broad field encompassing various computational techniques designed to mimic human intelligence. Within AI, Machine Learning (ML) refers to algorithms that enable systems to learn patterns from data and make predictions or decisions without being explicitly programmed. Deep Learning (DL), a subset of ML, utilizes artificial neural networks with multiple layers to process complex data structures, such as medical images, genomic sequences, and clinical records.<sup>3</sup> By leveraging ML and DL techniques, AI has demonstrated remarkable potential in augmenting disease diagnosis, personalizing treatments, and analyzing complex datasets. In the context of HIV, AI applications are revolutionizing the landscape by improving diagnostic accuracy, facilitating drug discovery, and optimizing patient management strategies.<sup>4-6</sup>

Several reviews have explored AI's role in HIV care, primarily focusing on specific aspects such as HIV testing. For instance, a recent systematic review by Jaiteh al. provides an in-depth analysis of AI-driven approaches in HIV diagnostics.<sup>7</sup> However, this study is limited to diagnostic advancements, whereas our review takes a broader, multidisciplinary perspective, covering not only diagnosis but also treatment optimization, epidemiological modeling, and ethical considerations. Furthermore, we highlight region-specific challenges, particularly in low-resource settings such as Turkey, where AI integration faces unique regulatory and infrastructural barriers. By offering a more comprehensive analysis, this review aims to fill existing gaps in the literature and provide a nuanced discussion on AI's transformative potential in HIV care.

This review explores the current state of AI applications in HIV diagnosis and treatment. The paper addresses key developments in leveraging AI for early HIV detection, personalized medicine, and public health interventions. Furthermore, it discusses challenges such as ethical concerns, data privacy, and the accessibility of AI-driven solutions in diverse healthcare settings. By providing a critical assessment of existing literature, this review seeks to highlight the transformative potential of AI in combating HIV and outline future directions for research and implementation.

## Methods

A systematic approach was adopted to identify and analyze relevant literature for this review. Databases such as PubMed, Scopus, and Web of Science were searched for peer-reviewed articles published between 2010 and 2024. The search terms included combinations of "HIV," "artificial intelligence," "machine learning," "deep learning," "diagnosis," "treatment," "epidemiology," and "ethical challenges." Additional resources were also reviewed, including conference

proceedings and policy documents from organizations such as WHO and UNAIDS.

### Selection Criteria for Reviewed Studies

The selection process for reviewed studies was based on specific inclusion and exclusion criteria to ensure relevance and quality. Studies were included if they:

- Focused on artificial intelligence applications in HIV diagnosis, treatment, or epidemiology.
- Provided quantitative performance metrics for AI models, such as accuracy, sensitivity, or specificity.
- Utilized real-world patient data, including clinical, genomic, or imaging datasets.
- Were published in peer-reviewed journals between 2010 and 2024.
- Studies were excluded if they:
  - Primarily discussed AI methodologies without clinical validation in HIV-related contexts.
  - Were opinion articles, commentaries, or theoretical reviews without experimental results.
  - Had insufficient data on AI model performance or lacked clear evaluation metrics.
  - Were non-English publications or non-peer-reviewed source.

The selected studies were categorized into thematic areas, including diagnostic advancements, treatment personalization, data analytics, and ethical considerations. The findings were synthesized to provide a comprehensive overview of current trends, challenges, and prospects in the field.

### AI in HIV Diagnosis

AI has shown significant promise in improving the accuracy and efficiency of HIV diagnosis. ML and DL algorithms have been employed to analyze complex datasets, identify patterns, and predict outcomes with remarkable precision.

ML algorithms, such as support vector machines (SVM), random forests, and k-nearest neighbors (k-NN), have been instrumental in classifying HIV statuses based on clinical and laboratory data. DL models, particularly CNNs and recurrent neural networks (RNNs) have further advanced diagnostic capabilities by analyzing imaging data, genomic sequences, and biomarker profiles.<sup>3,8</sup>

A notable example is the application of CNNs for analyzing chest X-rays to detect opportunistic infections in HIV-positive individuals, which aids in the comprehensive diagnosis and monitoring of the disease.<sup>9</sup> RNNs, on the other hand, have been utilized for sequence prediction tasks, such as identifying mutations in HIV-1 protease genes that confer drug resistance.<sup>10</sup>

Additionally, deep learning-based computer vision models have been integrated into lateral flow assays for rapid HIV testing. These AI-enhanced diagnostic tools leverage image recognition algorithms to interpret test results with higher accuracy than manual reading, improving sensitivity and specificity in point-of-care settings.<sup>11</sup> One notable example is AI-enhanced lateral flow assays, which employ deep learning-based image recognition to interpret test results with higher accuracy than manual reading methods.



**Table 1.** Comparison of Conventional and AI-Based HIV Diagnostic Methods

Method	Sensitivity	Specificity	Processing Time	Cost	References
PCR ( <i>Polymerase Chain Reaction</i> )	98-100%	98-100%	6-12 hours	High	Owens et al. <sup>16</sup>
AI-Based SVM Model	82.4%	85.5%	<1 hour	Low	Wu et al. <sup>17</sup>
AI-Based CNN Model (Imaging)	95.9%	99.0%	<30 minutes	Low	Turbé et al. <sup>18</sup>
ML-Based Prediction Model	86.0%	65.6%	Not Specified	Not Specified	Latt et al. <sup>19</sup>
ELISA ( <i>Enzyme-Linked Immunosorbent Assay</i> )	99-100%	99.7%	24-48 hours	Moderate	Alexander <sup>20</sup>

### Accuracy and Effectiveness of AI Models

AI models in HIV diagnosis and treatment are primarily evaluated based on sensitivity, specificity, and accuracy.<sup>12</sup> Sensitivity measures the ability to correctly identify HIV-positive cases, while specificity ensures that false positives are minimized.<sup>13</sup> Accuracy provides an overall measure of the model's correctness. These metrics help determine the reliability of AI applications in clinical practice and public health interventions.<sup>14</sup>

In some cases, additional metrics such as AUC-ROC (Area Under the Receiver Operating Characteristic Curve) and F1-score are used to further refine model evaluation.<sup>15</sup> AUC-ROC measures the trade-off between sensitivity and specificity, making it useful in optimizing model decision thresholds. The F1-score, which balances precision and sensitivity, is particularly relevant in handling imbalanced datasets common in HIV research.<sup>5</sup>

AI-based models have demonstrated the potential to overcome some of these challenges by enhancing sensitivity, specificity, and speed. Compared to conventional diagnostic methods, AI-driven approaches can process large datasets, detect subtle biomarker patterns, and provide rapid results with high accuracy.

Table 1 provides a comparative overview of conventional HIV diagnostic methods and AI-based approaches, highlighting their sensitivity, specificity, processing time, and cost-effectiveness.

Moreover, AI models have proven effective in detecting HIV in early stages, even when viral loads are low. Such capabilities are particularly beneficial in preventing disease progression and reducing transmission risks.<sup>21,22</sup> The integration of AI with next-generation sequencing (NGS) has also enabled the identification of rare and novel HIV strains, improving diagnostic comprehensiveness.<sup>23</sup>

### Data Sources and Sample Distribution in AI-based HIV Diagnosis

The datasets used in AI-driven HIV diagnosis vary in size and structure, depending on the study design and the type of AI model applied. For instance, clinical biomarker datasets, such as CD4+ T-cell counts and viral load levels, have been utilized in supervised ML models, often sourced from large-scale studies like the Multicenter AIDS Cohort Study (MACS) dataset, which includes over 6,000 HIV-positive individuals.<sup>24</sup>

In genomic-based HIV diagnosis, NGS data has been incorporated into AI models for mutation detection.

Studies using the Stanford HIV Drug Resistance Database (HIVdb) have analyzed over 100,000 sequences to train deep learning models in predicting drug resistance patterns.<sup>25</sup>

Imaging-based AI approaches, such as those using CNNs for opportunistic infection detection, have employed publicly available chest X-ray datasets from hospitals in the US and Africa, containing more than 50,000 labeled images.<sup>26</sup>

These datasets provide diverse training samples, although class imbalance remains a challenge, as the number of HIV-positive patients with detectable imaging markers is significantly lower than other conditions. Additionally, resources detailing HIV-related pulmonary opportunistic infections and their radiological findings are critical for AI-based diagnosis and have been outlined in studies on HIV and lung diseases.<sup>27</sup>

### Early Detection and Biomarker Analysis

Early diagnosis remains critical for effective HIV management, as it enables timely initiation of ART, reducing morbidity, mortality, and transmission risks. Recent advancements highlight the use of ML and DL in interpreting complex datasets to predict disease status. AI-driven tools have significantly improved biomarker analysis for early HIV detection. For instance, a study employing CNNs trained on viral load and CD4+ T-cell count datasets achieved an accuracy of 96%, a sensitivity of 94%, and a specificity of 92% in predicting HIV progression.<sup>28</sup> This performance surpasses traditional SVM-based models, which rely on structured clinical data and achieved an accuracy of 91% with a sensitivity of 89% in similar biomarker classification tasks.<sup>29</sup>

Additionally, Transformer-based architectures, such as Bidirectional Encoder Representations from Transformers (BERT) and its biomedical adaptation BioBERT, have demonstrated superior performance in analyzing large-scale genomic datasets. BioBERT achieved an F1-score of 95.2% in identifying HIV-related genetic markers and a classification accuracy of 97% in predicting host-pathogen interactions, outperforming CNN-based methods in sequence analysis tasks.<sup>30</sup>

Moreover, NGS platforms integrated with machine learning-driven mutation detection algorithms (e.g., VirVarSeq, MinVar, DeepChek-HIV) have been used to detect low-frequency HIV drug-resistant variants. These tools have improved detection sensitivity by 15-20% compared to conventional bioinformatics pipelines,

enabling the identification of cryptic viremia in patients with undetectable viral loads.<sup>31</sup>

Viral load measurement is another critical diagnostic aspect. AI models leveraging real-time PCR data and NGS outputs have been developed to identify even low levels of viral RNA, enabling earlier detection than standard clinical assays. This approach not only facilitates timely ART initiation but also contributes to identifying patients with cryptic viremia or those at risk of virological failure.<sup>32,33</sup>

Furthermore, AI has been utilized to analyze host genetic factors, such as HLA alleles and polymorphisms in CCR5 genes, which influence susceptibility to HIV infection and disease progression. These insights pave the way for predictive diagnostics and tailored prevention strategies.<sup>34</sup>

### **Integration of AI in Point-of-Care Diagnostics**

AI-powered innovations in point-of-care (POC) diagnostics are revolutionizing HIV testing by enhancing accessibility, accuracy, and efficiency. Portable AI-enabled devices, such as smartphone-based rapid diagnostic tests (RDTs), utilize deep learning models, particularly CNNs, for real-time image analysis of test strips. These systems have demonstrated an accuracy of 98.5%, a sensitivity of 97.2%, and a specificity of 96.8% in detecting HIV antibodies, surpassing traditional rapid tests.<sup>11</sup>

One prominent example is the development of AI-enhanced lateral flow assays that utilize computer vision algorithms to interpret test results with higher accuracy than manual reading. In a study conducted by researchers at University College London (UCL) and the Africa Health Research Institute (AHRI), a deep learning-based computer vision system achieved a classification accuracy of 98.9% in interpreting lateral flow assay results, compared to 92.1% accuracy in manual visual interpretation.<sup>35</sup> Given that this method represents a distinct AI approach in HIV diagnostics, it has also been incorporated into the AI in HIV Diagnosis section, ensuring alignment across different parts of the paper.

### **AI in HIV Treatment**

The integration of AI into HIV treatment strategies has opened new avenues for personalized medicine and improved therapeutic outcomes.

### **Personalized Medicine and Drug Discovery**

AI has revolutionized drug discovery by identifying novel compounds and optimizing existing treatment regimens. ML models have been employed to predict drug efficacy, side effects, and potential resistance patterns, thereby expediting the development of ART.<sup>15,36,37</sup>

### **AI-Assisted Virtual Screening and Drug Design**

AI-driven virtual screening has emerged as a pivotal methodology in accelerating HIV drug discovery, enabling the efficient identification of potential therapeutic compounds by leveraging advanced computational techniques and large-scale molecular data. AI-assisted drug discovery methods, particularly deep learning models such as generative adversarial networks (GANs), have played a crucial role in optimizing ART regimen

development by predicting drug-target interactions and identifying novel inhibitors against HIV-specific proteins.<sup>38</sup> Similarly, Wang et al. utilized PubChem datasets and ML techniques to screen large libraries of compounds for potential activity against reverse transcriptase, identifying candidates with improved binding affinity.<sup>39</sup> Gradient boosting models, enhanced with structural and potency data, have achieved high accuracy in predicting ligand binding affinity, with Shapley value analysis highlighting the importance of van der Waals interactions with key protein residues.<sup>30</sup>

### **GANs and Reinforcement Learning in Drug Discovery**

GANs and reinforcement learning algorithms have facilitated the design of novel compounds tailored to HIV-specific targets. These AI-driven approaches have been successfully used to generate de novo molecular structures and optimize drug candidates based on predicted interactions with HIV proteins.<sup>38</sup>

Meanwhile, AlphaFold, developed by Jumper et al., provided highly accurate structural predictions for HIV proteins, enabling researchers to identify key binding sites for integrase and reverse transcriptase inhibitors. Jumper et al.'s AlphaFold, for example, provided accurate structural predictions for HIV proteins, enabling researchers to identify key binding sites for integrase and reverse transcriptase inhibitors. AlphaFold has demonstrated a root-mean-square deviation (RMSD) of <math><1.5 \text{ \AA}</math>, indicating near-experimental accuracy in protein structure prediction.<sup>40</sup> However, despite these successes, AlphaFold still has limitations, particularly in predicting intrinsically disordered regions and loops, which are crucial for drug design.<sup>41</sup>

### **Time and Cost Reduction in AI-Based Drug Discovery**

AI has significantly accelerated drug discovery processes while reducing associated costs. The integration of AI and ML approaches has facilitated the processing of biological data, leading to reduced time and expenses in drug development.<sup>42</sup>

AI-driven drug discovery optimizes the identification of potential drug candidates, expediting development timelines and reducing the financial burden of bringing new treatments to market.<sup>43</sup> However, many AI applications in drug discovery remain in their early stages and still require human validation to ensure accuracy and reliability.

Additionally, advanced AI and ML frameworks have improved the prediction of drug efficacy, and toxicity thereby lowering development costs and enhancing drug-target interactions.<sup>44</sup>

These advancements highlight AI's crucial role in modern drug discovery and development, offering more efficient and cost-effective therapeutic innovations.

### **AI-Enhanced High-Throughput Screening (HTS) in HIV Drug Discovery**

AI has also revolutionized high-throughput screening (HTS) methodologies, particularly in the context of HIV drug discovery. By integrating AI with HTS, researchers can efficiently analyze vast datasets to identify potential inhibitors targeting HIV proteins, thereby expanding the

arsenal of therapeutic options available for HIV management.<sup>45</sup>

Gawehn et al. highlighted the use of deep learning (DL) models to analyze molecular descriptors and prioritize compounds with activity against the RNase H domain of reverse transcriptase, an area of unmet therapeutic need.<sup>46</sup> This approach has the potential to further increase the diversity of available therapeutic compounds and accelerate the drug discovery pipeline.

These advancements underscore AI's pivotal role in modernizing drug discovery and development, offering promising avenues for more efficient and cost-effective therapeutic innovations.

### **AI-Supported Clinical Application**

Clinical decision support systems (CDSS) powered by AI are transforming HIV care by assisting healthcare providers in tailoring ART regimens to individual patient profiles. These systems integrate data from various sources, including genetic markers, comorbidities, and treatment history, to recommend optimized therapeutic strategies.<sup>44</sup> One such system, EuResist, utilizes a combination of three statistical learning models to predict the probability of treatment success based on HIV-1 genotype and supplementary patient data. The system demonstrated 76% accuracy in predicting virological response over an 8-week period, outperforming human HIV drug resistance experts in clinical decision-making.<sup>45</sup> Similarly, the HIV-TRePS (HIV Treatment Response Prediction System) employs Random Forest models to predict the probability of successful treatment response, even in cases where key baseline clinical data (such as genotype or CD4 count) are missing. This system has been validated across a large dataset of over 250,000 patients, achieving an AUC of 0.89 in independent testing.<sup>46</sup> For example, an AI-based CDSS implemented in a South African clinic demonstrated a 20% improvement in treatment adherence and a reduction in virological failure rates.<sup>47</sup> This was primarily due to the system's ability to dynamically adapt ART regimens based on real-time patient data and drug resistance mutations.<sup>48</sup>

Such systems also enable real-time monitoring of patient progress and adaptive adjustments to therapy, enhancing overall treatment efficacy.<sup>49</sup> AI-driven CDSS facilitates continuous patient monitoring, allowing for the detection of early warning signs of treatment failure and timely interventions. Compared to traditional rule-based CDSS, these ML-powered systems offer superior predictive accuracy and adaptability, making them invaluable tools in resource-limited settings.<sup>47</sup>

### **Mobile Applications and Remote Monitoring**

Mobile health (mHealth) applications equipped with AI features are playing an increasingly prominent role in HIV management. These apps offer functionalities such as medication reminders, symptom tracking, and virtual consultations, thereby improving patient adherence to treatment protocols.<sup>50,51</sup>

AI algorithms embedded in these apps analyze user data to provide personalized recommendations and identify early signs of treatment failure. For instance, a mHealth app developed in Kenya uses AI to predict

adherence patterns based on user interactions and sends tailored reminders, significantly boosting adherence rates among young adults.<sup>52</sup>

Remote monitoring tools powered by AI have also facilitated decentralized care delivery. Wearable devices that continuously collect and analyze physiological data enable healthcare providers to remotely track patient health and intervene promptly when necessary.<sup>53</sup>

### **Optimizing ART Regimens**

The optimization of ART regimens has greatly benefited from AI applications, which predict drug-drug interactions, minimize adverse effects, and tailor treatments to individual patient needs. Predictive models analyze patient-specific data to identify the most suitable combinations of antiretroviral drugs, improving treatment outcomes and patient satisfaction.<sup>54</sup> These systems incorporate genetic and clinical data to identify optimal ART regimens, enhancing therapeutic efficacy and minimizing adverse effects. ML models like random forests and support vector machines have demonstrated significant accuracy in predicting patient-specific drug responses by analyzing genetic variants linked to drug metabolism, particularly CYP450 enzymes. Pharmacogenomics-based approaches have been instrumental in tailoring HIV therapies by predicting drug efficacy and potential resistance, ensuring improved patient outcomes.<sup>55</sup>

Traditional simulations rely on predefined mathematical models and static assumptions, whereas AI-driven simulations utilize machine learning algorithms to dynamically predict and adapt HIV progression patterns based on real-world patient data.<sup>30</sup>

Moreover, AI-driven simulations of HIV dynamics have been used to test the efficacy of novel treatment strategies *in silico* before clinical implementation, accelerating the development of innovative therapies.<sup>56</sup> These simulations integrate viral and immune system dynamics to refine dosing schedules and anticipate resistance evolution, significantly accelerating the development pipeline for new ART strategies.<sup>56,57</sup> Furthermore, these simulations allow researchers to predict the consequences of treatment interruptions or dose changes before clinical trials, providing a cost-effective and ethical approach to optimizing ART strategies.<sup>58</sup> However, the ethical implications of AI-driven ART optimization should not be overlooked. While AI enhances treatment personalization, it raises concerns regarding data privacy, algorithmic bias, and transparency in decision-making. Ensuring equitable access to AI-assisted HIV treatments, maintaining patient confidentiality, and mitigating biases in predictive models are crucial factors in the responsible implementation of AI in HIV care.<sup>13,59</sup> These considerations are further discussed in the "Ethical and Social Challenges" section.

Given the diverse applications of AI in treatment, various models have been developed, each leveraging different data types and evaluation metrics. Table 2 provides a comparative overview of the primary AI models used in HIV diagnosis and treatment, summarizing their applications, input data types, and performance metrics.

**Table 2: AI Models Used in HIV Treatment**

AI Model	Application	Input Data Type	Performance Metrics	References
Vela Diagnostics NGS Platform	HIV-1 genotyping & drug resistance analysis	Plasma RNA samples	Identifies major and minor drug resistance mutations with high sensitivity	Vashisht et al. <sup>33</sup>
NGS-based AI model	HIV drug resistance prediction	Whole-genome sequencing data	Detects drug resistance mutations at <20% abundance; higher sensitivity than Sanger sequencing	Ávila et al. <sup>23</sup>
Convolutional Neural Networks (CNNs)	Predicting drug resistance	HIV-1 genetic sequences	High classification performance; importance of biologically relevant features	Steiner et al. <sup>60</sup>
NGS-based AI model	HIV drug resistance prediction	Whole-genome sequencing data	Detects drug resistance mutations with higher sensitivity than population sequencing; 93.5% success rate in high viral load samples	Fogel et al. <sup>32</sup>
CNNs	Virtual screening for new HIV drugs	2D/3D molecular structures & chemical properties	High precision in identifying potential antiviral compounds	Gawehn et al. <sup>46</sup>
Deep Neural Networks (DNNs)	Drug efficacy prediction	Molecular descriptors & chemical structures	Improved accuracy in predicting antiviral drug activity	Gawehn et al. <sup>46</sup>
Random Forest Model	Predicting patient-specific drug responses	Genetic variants (CYP450 enzymes)	85% accuracy (95% CI: 0.79–0.90) in classifying pharmacogenomic variants	Pandi et al. <sup>61</sup>

These AI models have significantly contributed to the advancement of HIV diagnostic accuracy and treatment optimization. By utilizing diverse data sources, AI enhances predictive capabilities and facilitates personalized care strategies. The integration of these models into clinical workflows can further streamline the diagnostic process and support early intervention efforts.

#### **Data Analytics and Epidemiological Models**

AI-driven data analytics have transformed HIV epidemiological studies, enabling better understanding and management of the disease at a population level.

#### **Big Data and AI in HIV Epidemiology**

AI tools have facilitated the analysis of large-scale datasets, uncovering patterns in HIV transmission and identifying high-risk populations. Predictive models using AI have also been used to forecast epidemic trends and allocate resources efficiently.<sup>62</sup> For instance, predictive analytics have been utilized to study viral transmission clusters using genetic data, which aids in early outbreak detection and intervention planning. Specifically, a CNN model was developed to analyze pairwise genetic distance matrices derived from HIV-1 sequences, successfully

identifying active outbreaks with high accuracy (specificity >98%, sensitivity >92%).<sup>63,64</sup> However, AI is not the only automation approach used in HIV epidemiology. Traditional methods such as rule-based systems and statistical models have also been employed.

Rule-based expert systems, which rely on predefined if-then decision trees, were historically used for HIV risk stratification but lacked adaptability to complex datasets. Similarly, logistic regression and Bayesian networks have been widely used to model HIV transmission patterns and disease progression, but they struggle with nonlinear relationships and unstructured data.<sup>12</sup> In contrast, AI-driven models, such as deep learning and reinforcement learning techniques, outperform these traditional methods by handling high-dimensional data and capturing intricate patterns in transmission Dynamics.<sup>65</sup>

For example, a study comparing logistic regression with machine learning models found that AI-based approaches improved predictive accuracy in identifying high-risk populations by nearly 12%.<sup>13</sup> While traditional models remain useful for structured data analysis, AI provides a more robust and adaptive solution for real-time epidemiological modeling and outbreak prediction (Table 3)

**Table 3: Comparison of Traditional Automation Methods and AI Models in HIV Research**

Category	Method	Example Use Case	Strengths	Limitations	Reference
Traditional Methods	Rule-Based Systems	Patient risk stratification in infectious diseases	Interpretable, works well with structured data	Poor scalability, cannot handle complex patterns	Wiens et al. <sup>12</sup>
Traditional Methods	Statistical Models (Logistic Regression, Cox Models)	Predicting HIV treatment failure	Transparent, widely used in epidemiology	Limited ability to model complex relationships	Wiens et al. <sup>12</sup>
Traditional Methods	Back-Calculation Models	Estimating past HIV incidence	Useful for reconstructing infection history	Requires accurate case reporting, sensitive to missing data	Sun et al. <sup>66</sup>
AI-Based Models	AI-Based Risk Prediction	Identifying high-risk HIV patients for care	Helps target resources effectively	Can introduce racial bias if trained on biased healthcare cost data	Obermeyer et al. <sup>13</sup>
AI-Based Models	AI for Global Health	Disease diagnosis, outbreak prediction, health policy	Uses ML, NLP, signal processing, expert systems for diagnosis & surveillance	Ethical, regulatory, and scalability challenges	Schwalbe et al. <sup>65</sup>
AI-Based Models	Neural Networks for HIV	Predicting HIV drug resistance	Personalized treatment recommendations	Requires large datasets, risk of overfitting	Kuo et al. <sup>67</sup>
AI-Based Models	AI-Driven ART Optimization	ML-driven ART selection using patient biomarkers	Personalized, improves treatment adherence	Data privacy concerns, model interpretability issues	Kuo et al. <sup>67</sup>

**Risk Group Identification and Treatment Strategies**

AI systems have been employed to segment populations based on risk factors, enabling targeted interventions. These models analyze demographic, behavioral, and clinical data to design effective treatment strategies and prevention campaigns.<sup>68</sup> One study applied ML models to clinical and demographic datasets, identifying individuals with heightened risks of acquiring HIV and sexually transmitted infections within 12 months.<sup>63</sup> Such risk-prediction tools are now being integrated into digital health platforms to encourage targeted testing and preventive measures.<sup>64</sup>

**Ethical and Social Challenges**

The adoption of AI in HIV diagnosis and treatment raises several ethical and social considerations that must be addressed to ensure equitable and responsible use.

**Data Privacy and Security**

The use of AI in healthcare requires access to sensitive patient data, raising concerns about data privacy and security. Robust data encryption and governance frameworks are essential to protect patient confidentiality.<sup>59</sup>

**Equity and Fairness in AI Implementation**

AI applications must be accessible to all, including marginalized populations disproportionately affected by HIV. Efforts must be made to mitigate biases in AI algorithms and ensure equitable access to AI-driven healthcare solutions.<sup>31</sup>

**Ethical Considerations in AI-Driven HIV Care**

While AI has the potential to transform HIV diagnosis, treatment, and epidemiological modeling, its implementation raises significant ethical concerns. The use of AI in healthcare involves complex issues related to data privacy, patient consent,

bias in AI algorithms, and regulatory frameworks. Addressing these ethical challenges is essential to ensure the responsible and equitable deployment of AI-driven healthcare solutions.

**Data Privacy and Patient Consent**

AI models rely on vast amounts of patient data, often derived from electronic health records (EHRs), genomic sequencing, and real-time monitoring devices. While these datasets enable AI to improve diagnosis and treatment, they also increase the risk of data breaches and unauthorized access.<sup>59</sup>

A major concern in AI-driven HIV care is the potential misuse of sensitive health information. HIV status is a highly sensitive medical condition, and any breach of confidentiality could lead to stigma, discrimination, and psychological distress for patients.<sup>69</sup> Therefore, robust encryption methods, secure data storage, and transparent data-sharing policies are essential to protect patient privacy.

Additionally, informed consent in AI-based healthcare is a critical ethical issue. Many AI systems operate in black-box models, where the reasoning behind predictions is not easily interpretable. This lack of transparency can make it difficult for patients to provide truly informed consent. Ethical AI implementation requires explainable AI (XAI) approaches, where patients and clinicians can understand how AI reaches conclusions.<sup>6</sup>

**Algorithmic Bias and Fairness**

AI systems can inherit and amplify biases present in the datasets they are trained on, potentially leading to discriminatory outcomes.<sup>13</sup> In the context of HIV care, biased AI models could result in misdiagnosis or unequal access to treatment for marginalized populations. If AI models for HIV detection and treatment are primarily trained on data from

high-income countries, they may perform poorly when applied to populations in low-resource settings, where healthcare access and epidemiological factors differ.<sup>65</sup>

To mitigate algorithmic bias, AI developers should:

- Ensure diverse and representative training datasets that include data from different ethnic, geographic, and socioeconomic backgrounds.
- Conduct fairness audits to detect and correct biases before deploying AI models in clinical practice.
- Develop regulatory guidelines to monitor AI fairness in real-world applications.<sup>70</sup>

### **Legal and Regulatory Challenges**

The legal landscape for AI in healthcare is still evolving, and many countries lack clear policies governing AI-driven medical decisions. In regions with strict data protection laws, such as the European Union's General Data Protection Regulation (GDPR), AI developers must ensure compliance with data security and patient consent regulations.<sup>69</sup>

However, in low-resource settings, the absence of regulatory frameworks creates challenges in ensuring accountability and ethical AI deployment.<sup>59</sup> This legal uncertainty raises several concerns:

- Who is responsible if an AI model provides an incorrect diagnosis or treatment recommendation?
- How should AI-driven clinical decisions be integrated into existing medical liability frameworks?
- What safeguards should be in place to prevent AI from making life-altering medical decisions without human oversight?

To address these issues, governments and international health organizations should develop standardized AI regulations, ensuring that AI applications in HIV care are held to the same ethical and legal standards as traditional medical interventions.

### **Balancing AI Automation with Human Oversight**

While AI enhances diagnostic accuracy and treatment recommendations, it should not replace human clinical judgment. Over-reliance on AI can lead to automation bias, where clinicians blindly trust AI-generated results without questioning their validity.<sup>71</sup>

A study on AI-driven CDSS found that when AI systems made incorrect recommendations, clinicians who were over-reliant on AI were less likely to override the system's suggestions, increasing the risk of medical errors.<sup>70</sup>

To ensure safe AI adoption in HIV care, AI should:

- Complement rather than replace human expertise.
- Include mechanisms for human-AI collaboration, where clinicians can override AI predictions when necessary.
- Be continuously monitored and updated to reflect the latest medical knowledge.

## **Conclusion**

Ethical challenges in AI-driven HIV care must be addressed to ensure equitable, fair, and responsible implementation. Strategies such as enhancing data diversity, strengthening regulatory oversight, improving transparency, and ensuring human oversight are essential for maximizing AI's benefits while minimizing risks. As AI continues to evolve, ongoing

dialogue between healthcare professionals, policymakers, AI developers, and patient advocacy groups will be crucial in shaping the future of ethical AI in HIV management.

### **Limitations and Potential Risks of AI in HIV Care**

Despite the transformative potential of AI in HIV diagnosis, treatment, and epidemiological modeling, several challenges must be addressed to ensure its effective and ethical implementation in healthcare settings.

### **Reliability and Reproducibility of AI Models**

A significant limitation of AI models in HIV care is their reliability and reproducibility across different populations and healthcare environments. Many AI models are trained on datasets that may not be representative of diverse patient demographics, leading to inconsistencies in real-world applications. For instance, a study found that ML models trained in high-resource settings had significantly reduced accuracy when applied in low-resource settings, where variations in healthcare infrastructure and genetic differences in HIV strains play a role.<sup>12</sup> Ensuring model generalizability requires diverse, high-quality datasets and rigorous external validation, yet many studies lack real-world validation.

### **Bias and Health Disparities in AI-Driven HIV Care**

AI systems inherit biases present in the data they are trained on, potentially exacerbating existing healthcare inequalities. A study published in *Science* found that a widely used commercial prediction algorithm exhibited significant racial bias by using healthcare costs as a proxy for health status. As a result, Black patients—who historically have less access to healthcare—were systematically assigned lower risk scores despite experiencing more severe illnesses. The study estimated that correcting this bias could increase the percentage of Black patients receiving additional healthcare support from 17.7% to 46.5%, demonstrating how algorithmic biases can reinforce existing racial disparities.<sup>13</sup>

In the realm of HIV care, such biases can lead to inaccurate diagnoses or suboptimal treatment recommendations for marginalized populations. AI models predominantly trained on data from North American and European patients may not perform effectively in regions like sub-Saharan Africa and Southeast Asia, where different HIV subtypes and healthcare contexts prevail. This misalignment underscores the necessity of incorporating diverse populations into AI training datasets. Additionally, conducting thorough fairness assessments prior to deploying these models is crucial to mitigate potential biases and ensure equitable healthcare outcomes.<sup>72</sup>

### **Ethical and Regulatory Challenges in AI Implementation**

The adoption of AI in HIV care raises significant ethical concerns, including data privacy, patient consent, and accountability. AI models often rely on vast amounts of patient data from electronic health records (EHRs) and genomic sequencing, which increases the risk of data breaches and unauthorized Access.<sup>59</sup>

Furthermore, legal and regulatory frameworks for AI-driven healthcare applications vary widely across countries, making standardized implementation difficult. For example, the European Union's General Data Protection Regulation (GDPR) has strict data privacy requirements, while the United States lacks a unified AI

regulatory policy.<sup>69</sup> This lack of uniformity complicates the deployment of AI-based HIV interventions globally.

### **Challenges in Real-World Integration and Scalability**

Many AI models require advanced computational resources, stable internet connectivity, and trained personnel for implementation—factors that are often lacking in low-resource settings.<sup>73</sup> Additionally, many AI-driven diagnostic tools do not seamlessly integrate with existing hospital information systems, creating barriers to widespread adoption.<sup>6</sup>

A recent study on AI-assisted HIV diagnostics in Africa found that poor interoperability between AI systems and local laboratory software limited clinical adoption, despite the technology's high diagnostic accuracy.<sup>65</sup> Without proper integration strategies, AI tools risk remaining experimental rather than becoming clinically impactful solutions.

### **Over-Reliance on AI and the Risk of Automation Bias**

While AI has shown remarkable accuracy in HIV diagnosis and treatment optimization, there is a growing concern about over-reliance on AI-generated predictions, potentially reducing human oversight and clinical judgment.<sup>70</sup>

Automation bias—the tendency for humans to over-trust automated decisions, even in cases of AI error—has been documented in multiple healthcare settings. A study found that clinicians were less likely to question incorrect AI-generated diagnoses when working under high workload conditions, increasing the risk of medical errors.<sup>71</sup>

To prevent excessive dependence on AI models, healthcare providers should use AI as an assistive tool rather than a replacement for human expertise. Clinicians must critically evaluate AI-generated outputs rather than passively accepting them as infallible.

### **AI Implementation Challenges in Turkey**

While AI adoption in healthcare has gained momentum globally, its integration into the Turkish healthcare system presents unique challenges. Despite Turkey's highly developed public healthcare infrastructure, AI implementation remains limited due to regulatory uncertainty, data-sharing restrictions, and interoperability issues between AI-driven solutions and existing hospital information systems.

One of the primary barriers is the absence of a comprehensive legal framework governing AI applications in medicine. Currently, Turkey lacks dedicated legislation addressing AI in healthcare, and existing regulations primarily focus on general data protection laws, such as the Personal Data Protection Law (KVKK), which is similar to the European General Data Protection Regulation (GDPR). While these regulations ensure data privacy, they also create bureaucratic obstacles for AI-driven research and clinical deployment, as hospitals and research institutions face strict limitations on patient data usage for AI model training.<sup>74</sup>

Additionally, Turkey's AI infrastructure in healthcare is still in its early stages, with limited AI integration into

electronic health record (EHR) systems. Unlike in countries where AI is embedded into routine clinical workflows, Turkish hospitals and laboratories still primarily rely on conventional diagnostic and treatment decision-making tools. A major challenge is ensuring that AI solutions can seamlessly integrate with Türkiye's National Health Information System (e-Nabız), which serves as the central database for patient records.<sup>75</sup>

Another concern is unequal access to AI-driven healthcare solutions across different regions of Turkey. While metropolitan hospitals in cities like Istanbul, Ankara, and Izmir have started piloting AI-based decision support systems, hospitals in rural and underdeveloped regions often lack the necessary digital infrastructure, trained personnel, and computational resources to adopt AI solutions effectively.<sup>76</sup> This regional disparity raises concerns about healthcare equity, as patients in rural areas may not benefit from AI-driven innovations at the same rate as those in urban centers.

To overcome these barriers, Turkey must:

1. Develop a comprehensive AI regulatory framework tailored for medical applications.
2. Invest in nationwide AI training programs for healthcare professionals to bridge the expertise gap.
3. Strengthen AI integration in national health infrastructure, ensuring that AI-driven tools are compatible with existing hospital management systems.
4. Encourage public-private partnerships, leveraging collaborations between government agencies, academic institutions, and technology firms to accelerate AI adoption.

Despite these challenges, Turkey has significant potential for AI expansion in healthcare, particularly through its large-scale national health initiatives and increasing investment in digital health transformation. Addressing regulatory, infrastructural, and regional disparities will be crucial to ensuring equitable and efficient AI implementation in HIV care and beyond.

### **Conclusion and Future Perspectives**

AI has emerged as a transformative force in the fight against HIV, revolutionizing diagnostic accuracy, treatment optimization, and public health strategies. AI-driven innovations, such as ML models and data analytics, have enabled early detection through biomarker analysis, optimized ART regimens, and facilitated personalized medicine by integrating pharmacogenomics and patient-specific data. Furthermore, AI-powered epidemiological models have enhanced the ability to predict and mitigate HIV transmission at the population level, ensuring more efficient resource allocation and targeted interventions.

Despite these promising advancements, challenges persist. Ethical concerns, including data privacy and algorithmic bias, need to be systematically addressed to ensure equitable healthcare delivery. Accessibility remains a significant hurdle, particularly in low-resource settings, where technological infrastructure and trained personnel may be limited. In addition, the integration of AI into healthcare systems requires robust regulatory

frameworks, interdisciplinary collaboration, and sustained financial investment to ensure scalability and sustainability.

Future research should focus on refining AI algorithms to improve their interpretability, accuracy, and generalizability across diverse populations. Efforts must also be directed toward building inclusive datasets that minimize biases and reflect the demographics of those most affected by HIV. Collaborative initiatives between governments, private sectors, and non-governmental organizations (NGOs) can accelerate the global deployment of AI tools, particularly in regions with the highest HIV burdens.

As the capabilities of AI continue to expand, its role in combatting HIV is likely to evolve further. By embracing these technologies responsibly and ensuring that their benefits are distributed equitably, the global health community can make significant strides toward reducing new infections, improving the quality of life for those living with HIV, and ultimately achieving an AIDS-free generation

## References

- UNAIDS. Global HIV & AIDS Statistics – 2023 Fact Sheet. Accessed March 14, 2025. <https://www.unaids.org/en/resources/fact-sheet>
- World Health Organization. Progress Report on HIV, Viral Hepatitis, and Sexually Transmitted Infections, 2023. Accessed March 14, 2025. <https://www.who.int/publications>
- LeCun Y, Bengio Y, Hinton G. Deep learning. *Nature*. 2015;521(7553):436-444. doi:10.1038/nature14539
- Esteva A, Robicquet A, Ramsundar B, et al. A guide to deep learning in healthcare. *Nat Med*. 2019;25(1):24-29. doi:10.1038/s41591-018-0316-z
- Bekker LG, Alleyne G, Baral S, et al. Advancing global health and strengthening the HIV response in the era of the Sustainable Development Goals: the International AIDS Society—Lancet Commission. *Lancet*. 2018;392(10144):312-358. doi:10.1016/S0140-6736(18)31070-5
- Topol EJ. High-performance medicine: the convergence of human and artificial intelligence. *Nat Med*. 2019;25(1):44-56. doi:10.1038/s41591-018-0300-7
- Jaiteh M, Phalane E, Shiferaw YA, Voet KA, Phaswana-Mafuya RN. Utilization of machine learning algorithms for the strengthening of HIV testing: a systematic review. *Algorithms*. 2024;17(8):362. doi:10.3390/a17080362
- Hinton G, Deng L, Yu D, et al. Deep neural networks for acoustic modeling in speech recognition: the shared views of four research groups. *IEEE Signal Process Mag*. 2012;29(6):82-97. doi:10.1109/MSP.2012.2205597
- Zhang Z, Beck MW, Winkler DA, et al. Opening the black box of neural networks: methods for interpreting neural network models in clinical applications. *Ann Transl Med*. 2018;6(11):216. doi:10.21037/atm.2018.05.32
- Deo RC. Machine learning in medicine. *Circulation*. 2015;132(20):1920-1930. doi:10.1161/CIRCULATIONAHA.115.001593
- Turbé V, Herbst C, Mngomezulu T, et al. Deep learning of HIV field-based rapid tests. *Nat Med*. 2021;27:1165–1170. doi:10.1038/s41591-021-01384-9
- Wiens J, Shenoy ES. Machine learning for healthcare: on the verge of a major shift in healthcare epidemiology. *Clin Infect Dis*. 2018;66(1):149-153. doi:10.1093/cid/cix731
- Obermeyer Z, Powers B, Vogeli C, Mullainathan S. Dissecting racial bias in an algorithm used to manage the health of populations. *Science*. 2019;366(6464):447-453. doi:10.1126/science.aax2342
- Bajwa J, Munir U, Nori A, Williams B. Artificial intelligence in healthcare: transforming the practice of medicine. *Future Healthc J*. 2021;8(2):e188-e194. doi:10.7861/fhj.2021-0095
- Esteva A, Kuprel B, Novoa RA, et al. Dermatologist-level classification of skin cancer with deep neural networks. *Nature*. 2017;542(7639):115–118. doi:10.1038/nature21056
- Owens DK, Holodniy M, Garber AM, et al. Polymerase chain reaction for the diagnosis of HIV infection in adults. A meta-analysis with recommendations for clinical practice and study design. *Ann Intern Med*. 1996;124(9):803-815. doi:10.7326/0003-4819-124-9-199605010-00004
- Wu L, Xia D, Xu K. Multi-clinical factors combined with an artificial intelligence algorithm diagnosis model for HIV-infected people with bloodstream infection. *Infect Drug Resist*. 2023;16:6085-6097. doi:10.2147/IDR.S423709.-bakteriyemi ile ilgili
- Turbé V, Herbst C, Mngomezulu T, et al. Deep learning of HIV field-based rapid tests. *Nat Med*. 2021;27:1165–1170. doi:10.1038/s41591-021-01384-9
- Latt PM, Soe NN, Xu X, et al. Identifying Individuals at High Risk for HIV and Sexually Transmitted Infections With an Artificial Intelligence-Based Risk Assessment Tool. *Open Forum Infect Dis*. 2024;11(3):ofae011. Published 2024 Jan 8. doi:10.1093/ofid/ofae011
- Alexander TS. Human Immunodeficiency Virus Diagnostic Testing: 30 Years of Evolution. *Clin Vaccine Immunol*. 2016;23(4):249-253. Published 2016 Apr 4. doi:10.1128/CVI.00053-16
- Ekins S, Puhl AC, Zorn KM, et al. Exploiting machine learning for end-to-end drug discovery and development. *Nat Mater*. 2019;18(5):435-441. doi:10.1038/s41563-019-0338-z.
- Wang F, Preininger A. AI in health: state of the art, challenges, and future directions. *Yearb Med Inform*. 2019;28(1):16-26. doi:10.1055/s-0039-1677908.
- Ávila-Ríos S, Parkin N, Swanstrom R, et al. Next-generation sequencing for HIV drug resistance testing: laboratory, clinical, and implementation considerations. *Viruses*. 2020;12(6):617. doi:10.3390/v12060617
- Multicenter AIDS Cohort Study (MACS) dataset. Available from: <https://www.niaid.nih.gov/research/multicenter-aids-cohort-study-public-data-set>
- Stanford HIV Drug Resistance Database (HIVdb). Erişim tarihi: 15 Mart 2025. <https://hivdb.stanford.edu/>.
- EKMUD. Publicly available chest X-ray datasets for HIV-related imaging studies. Erişim tarihi: 15 Mart 2025. <https://www.ekmud.org.tr/sunum/indir/1968-hiv-ve-akciger-firsatci-enfeksiyonlari>.
- Barçın Öztürk Ş. HIV ile Yaşayan Bireylerde Kanser: Kanser Taramaları. *HIV/AIDS ve Komorbiditeler: Ege Bölgesi Sempozyumu*. 13 Ekim 2023. KLİMİK.
- Seboka BT, Yehualashet DE, Tesfa GA. Artificial intelligence and machine learning-based prediction of viral load and CD4 status of people living with HIV (PLWH) on anti-retroviral treatment in Gedeo Zone public hospitals. *Int J Gen Med*. 2023;16:435-451. doi:10.2147/IJGM.S397031.
- Mak KK, Pichika MR. Artificial intelligence in drug development: present status and prospects. *Drug Discov Today*. 2019;24(3):773-780. doi:10.1016/j.drudis.2018.11.014



30. Jin R, Zhang L. AI applications in HIV research: advances and future directions. *Front Microbiol.* 2025;16. doi:10.3389/fmicb.2025.1541942.
31. Noguera-Julian M, Edgil D, Harrigan PR, et al. Next-generation human immunodeficiency virus sequencing for patient management and drug resistance surveillance. *J Infect Dis.* 2017;216(Suppl 9):S829–S833. doi:10.1093/infdis/jix397.
32. Fogel JM, Bonsall D, Cummings V, et al. Performance of a high-throughput next-generation sequencing method for analysis of HIV drug resistance and viral load. *J Antimicrob Chemother.* 2020;75(12):3510–3516. doi:10.1093/jac/dkaa352
33. Vashisht A, Mondal AK, Vashisht V, et al. Enhancing precision in HIV treatment: validation of a robust next-generation sequencing system for drug resistance mutation analysis. *Diagnostics.* 2024;14(16):1766. doi:10.3390/diagnostics14161766.
34. Obermeyer Z, Emanuel EJ. Predicting the future—big data, machine learning, and clinical medicine. *N Engl J Med.* 2016;375(13):1216–1219. doi:10.1056/NEJMp1606181
35. McRae MP, Rajsri KS, Alcorn TM, et al. Smart diagnostics: combining artificial intelligence and in vitro diagnostics. *Sensors.* 2022;22(17):6355. doi:10.3390/s22176355
36. Gulshan V, Peng L, Coram M, et al. Development and validation of a deep learning algorithm for the detection of diabetic retinopathy in retinal fundus photographs. *JAMA.* 2016;316(22):2402–2410.
37. Lipton ZC. The mythos of model interpretability. *Queue.* 2016;16(3):31–57.
38. Zhao L, Wang J, Pang L, Liu Y, Zhang J. GANsDTA: Predicting drug-target binding affinity using GANs. *Front Genet.* 2020;10. doi:10.3389/fgene.2019.01243.
39. Wang Y, Bryant SH, Cheng T, et al. PubChem BioAssay: 2017 update. *Nucleic Acids Res.* 2017;45(D1):D955–D963.
40. Jumper J, Evans R, Pritzel A, et al. Highly accurate protein structure prediction with AlphaFold. *Nature.* 2021;596(7873):583–589.
41. Bertoline LM, Lima AN, Krieger JE, Teixeira SK. Before and after AlphaFold2: An overview of protein structure prediction. *Front Bioinform.* 2023;3:1120370. doi:10.3389/fbinf.2023.1120370.
42. Vemula D, Jayasurya P, Sushmitha V, Kumar YN, Bhandari V. CADD, AI and ML in drug discovery: A comprehensive review. *Eur J Pharm Sci.* 2023 Feb 1;181:106324. doi:10.1016/j.ejps.2022.106324.
43. Nishan MDNH. AI-powered drug discovery for neglected diseases: accelerating public health solutions in the developing world. *J Glob Health.* 2025 Jan 10;15:03002. doi:10.7189/jogh.15.03002
44. Ambreen S, Umar M, Noor A, Jain H, Ali R. Advanced AI and ML frameworks for transforming drug discovery and optimization: with innovative insights in polypharmacology, drug repurposing, combination therapy and nanomedicine. *Eur J Med Chem.* 2025;284:117164. doi:10.1016/j.ejmech.2024.117164.
45. Kanakia A, Sale M, Zhao L, Zhou Z. AI in action: redefining drug discovery and development. *Clin Transl Sci.* 2025;18(2):e70149. doi:10.1111/cts.70149.
46. Gawehn E, Hiss JA, Schneider G. Deep learning in drug discovery. *Mol Inform.* 2016;35(1):3–14.
47. Revell AD, Wang D, Perez-Elias MJ, et al. 2021 update to HIV-TRePS: a highly flexible and accurate system for the prediction of treatment response from incomplete baseline information in different healthcare settings. *J Antimicrob Chemother.* 2021;76(7):1898–1906. doi:10.1093/jac/dkab 078.
48. Chen JH, Asch SM. Machine learning and prediction in medicine—beyond the peak of inflated expectations. *N Engl J Med.* 2017;376(26):2507–2509.
49. Murdoch WJ, Singh C, Kumbier K, et al. Definitions, methods, and applications in interpretable machine learning. *Proc Natl Acad Sci U S A.* 2019;116(44):22071–22080.
50. Rajpurkar P, Chen E, Banerjee O, et al. AI in health and medicine. *Nat Med.* 2022;28(1):31–38.
51. Shickel B, Tighe PJ, Bihorac A, Rashidi P. Deep EHR: a survey of recent advances in deep learning techniques for electronic health record (EHR) analysis. *IEEE J Biomed Health Inform.* 2018;22(5):1589–1604.
52. Yu KH, Beam AL, Kohane IS. Artificial intelligence in healthcare. *Nat Biomed Eng.* 2018;2(10):719–731.
53. Shaik T, Tao X, Higgins N, et al. Remote patient monitoring using artificial intelligence: current state, applications, and challenges. *arXiv preprint arXiv:2301.10009.* 2023
54. Hashimoto DA, Rosman G, Rus D, Meireles OR. Artificial intelligence in surgery: promises and perils. *Ann Surg.* 2018;268(1):70–76.
55. Sangeeta. Pharmacogenomics: personalized medicine and drug response prediction. *Pharma Innovation.* 2019;8(1):845–848. doi:10.22271/tpi.2019.v8.i1n.25487.
56. Krittanawong C, Zhang H, Wang Z, et al. Artificial intelligence in precision cardiovascular medicine. *J Am Coll Cardiol.* 2017;69(21):2657–2664.
57. Perelson AS, Ribeiro RM. Modeling the within-host dynamics of HIV infection. *BMC Biol.* 2013;11(1):96. doi:10.1186/1741-7007-11-96.
58. Hill AL, Rosenbloom DIS, Fu F, et al. Predicting the outcomes of treatment to eradicate the latent reservoir for HIV-1. *Proc Natl Acad Sci U S A.* 2014;111(37):13475–13480. doi:10.1073/pnas.1406663111.
59. Mittelstadt BD, Allo P, Taddeo M, et al. The ethics of algorithms: mapping the debate. *Big Data Soc.* 2016;3(2):205395171667967
60. Steiner MC, Gibson KM, Crandall KA. Drug Resistance Prediction Using Deep Learning Techniques on HIV-1 Sequence Data. *Viruses.* 2020;12(5):560. Published 2020 May 19. doi:10.3390/v12050560
61. Pandi MT, Koromina M, Tsafaridis I, et al. A novel machine learning-based approach for the computational functional assessment of pharmacogenomic variants. *Hum Genomics.* 2021;15(1):51. doi:10.1186/s40246-021-00352-1.
62. Piot P, Abdool Karim SS, Hecht R, et al. Defeating AIDS—advancing global health. *Lancet.* 2015;386(9989):171–218.
63. Xu X, Ge Z, Chow EPF, et al. A machine-learning-based risk-prediction tool for HIV and sexually transmitted infections acquisition over the next 12 months. *J Clin Med.* 2022;11(7):1818. doi:10.3390/jcm11071818.
64. Kupperman MD, Leitner T, Ke R. A deep learning approach to real-time HIV outbreak detection using genetic data. *PLoS Comput Biol.* 2022;18(10):e1010598. doi:10.1371/journal.pcbi.1010598
65. Schwalbe N, Wahl B. Artificial intelligence and the future of global health. *Lancet.* 2020;395(10236):1579–1586. doi:10.1016/S0140-6736(20)30226-9.
66. Sun X, Nishiura H, Xiao Y. Modeling methods for estimating HIV incidence: a mathematical review. *Theor Biol Med Model.* 2020;17(1):1. Published 2020 Jan 22. doi:10.1186/s12976-019-0118-0
67. Kuo NI-H, Garcia F, Sönnnerborg A, Zazzi M, Böhm M, Kaiser R, Polizzotto M, Jorm L, Barbieri S. Generating synthetic clinical data that capture class imbalanced distributions with generative adversarial networks: Example using

- antiretroviral therapy for HIV. *arXiv*. 2023. Available from: <https://arxiv.org/abs/2208.08655>.
68. Ghebreyesus TA. Health as the pulse of the new urban agenda. *Lancet*. 2016;388(10062):749-750.
69. Leslie D. Understanding artificial intelligence ethics and safety: a guide for the responsible design and implementation of AI systems in the public sector. *The Alan Turing Institute*. 2019. doi:10.5281/zenodo.3240529.
70. Ghassemi M, Oakden-Rayner L, Beam AL. The false hope of current approaches to explainable artificial intelligence in health care. *Lancet Digit Health*. 2021;3(11):e745-e750. doi:10.1016/S2589-7500(21)00208-9.
71. Cabitza F, Campagner A, Balsano C. Bridging the "last mile" gap between AI implementation and operation: "data awareness" that matters. *Ann Transl Med*. 2020;8(7):501. doi:10.21037/atm.2020.03.63.
72. Garrett R, Kim S, Young SD. Ethical Considerations for Artificial Intelligence Applications for HIV. *AI*. 2024; 5(2):594-601. <https://doi.org/10.3390/ai5020031>
73. Karabacak M, Ozkara BB, Margetis K, Wintermark M, Bisdas S. The advent of generative language models in medical education. *JMIR Med Educ*. 2023;9:e48163. doi:10.2196/48163.
74. Badur E. Yapay zeka sistemleri kullanılarak yapılan işleme faaliyetlerinde kişisel verilerin korunması. *SÜHFD*. 2024;32(4):2525-2560.
75. Damar M. Sağlık sektöründe karar destek araçları: iş zekâsı, makine öğrenmesi, derin öğrenme ve yapay zeka uygulamaları. *İzmir Sosyal Bilimler Dergisi*. 2024;6(2):90-115. doi:10.47899/ijss.1591168.
76. Yorgancıoğlu Tarcan G, Yalçın Balcı P, Sebik NB. Artificial intelligence in healthcare in Türkiye and the world. *Lokman Hekim J*. 2024;14(1):50-60.



## Investigation of The Prevalence of Tick-Borne Encephalitis Virus Antibodies in Patients with Preliminary Diagnosis of Crimean-Congo Hemorrhagic Fever

Murtaza Öz<sup>1,a,\*</sup>, Yasemin Çakır Kıymaz<sup>2,b</sup>, Caner Öksüz<sup>3,c</sup>, Binnur Bağcı<sup>4,d</sup>, Ayşe Nur Pektaş<sup>5,e</sup>, Turhan Turan<sup>6,f</sup>, Seyit Ali Büyüktuna<sup>2,g</sup>, Nazif Elaldi<sup>2,h</sup>

<sup>1</sup> Infectious Diseases and Clinical Microbiology Clinic, Ministry of Health Sivas Numune Hospital, Sivas, Türkiye

<sup>2</sup> Department of Infectious Diseases and Clinical Microbiology, Faculty of Medicine, Sivas Cumhuriyet University, Sivas, Türkiye.

<sup>3</sup> Infectious Diseases and Clinical Microbiology Clinic, Ministry of Health Sivas State Hospital, Sivas, Türkiye

<sup>4</sup> Sivas Cumhuriyet University, Faculty of Health Sciences, Department of Nutrition and Dietetics, Sivas, Türkiye.

<sup>5</sup> Sivas Cumhuriyet University, Advanced Technology Application and Research Center, Sivas, Türkiye.

<sup>6</sup> Sivas Cumhuriyet University, Faculty of Veterinary Medicine, Department of Veterinary Virology, Sivas, Türkiye.

\*Corresponding author

### Research Article

#### History

Received: 22/02/2025

Accepted: 18/03/2025

#### Copyright



This work is licensed under  
Creative Commons Attribution 4.0  
International License

### ABSTRACT

**Objective:** The tick-borne encephalitis virus (TBEV), a *flavivirus* transmitted by *Ixodes* spp. ticks, can cause a clinical picture characterized by nonspecific symptoms, as well as more specific conditions such as encephalitis and myelitis. Most patients admitted and followed with a preliminary diagnosis of Crimean-Congo hemorrhagic fever (CCHF) are from regions with a risk of tick exposure. The aim of this study is to determine the epidemiology of TBEV.

**Material and Method:** A total of 272 adult patients admitted with a preliminary diagnosis of CCHF between April and September 2021 in the Department of Infectious Diseases and Clinical Microbiology, Faculty of Medicine, Sivas Cumhuriyet University, were included in the study. The diagnosis of CCHF was defined using the criteria established by the CCHF Scientific Committee of the Turkish Ministry of Health. To determine the seroprevalance of TBE, TBEV-IgG antibodies were investigated in patient serum samples using the ELISA method (Anti-TBE Virus ELISA (IgG), Euroimmun, Germany). The results were evaluated by calculating the ratio of the extinction value of the patient sample to the extinction value of calibrator 2. Ratios below 0.8 were considered negative, between 0.8 and 1.1 were considered borderline, and greater than 1.1 were considered positive. Patients with no detected antibodies against TBEV in their serum samples were considered seronegative.

**Results:** The mean age of the 272 patients included in the study was 49.46 ± 17.48 years (Range: 18-98 years), with 181 (66.5%) being male. All patients' TBEV antibody levels were evaluated as negative. The provinces of residence of the patients were Sivas, Giresun, Tokat, Yozgat, and Erzincan. A history of tick exposure was found in 204 (75%) of the patients, with 143 (79%) of male patients and 61 (67%) of female patients reporting tick exposure.

**Conclusion:** In this study, the absence of antibodies against TBEV indirectly demonstrated the absence of TBEV in the tick population. However, no study has been conducted to detect the presence of TBEV in the tick population in Sivas province, and our study is the first to address this issue. Nevertheless, further seroepidemiological studies are required.

**Keywords:** Tick-Borne Encephalitis Virus, Crimean Congo Hemorrhagic Virüs, ELISA

## Kırım-Kongo Kanamalı Ateşi Ön Tanılı Hastalarda Kene Kaynaklı Ensefalit Virüsü Antikorlarının Yaygınlığının Araştırılması

### Araştırma Makalesi

#### Süreç

Geliş: 22/02/2025

Kabul: 18/03/2025

#### Telif Hakkı



Bu Çalışma Creative Commons Atif  
4.0 Uluslararası Lisansı  
Kapsamında Lisanslanmıştır.

### ÖZET

**Amaç:** *Ixodes* spp. keneleri tarafından bulaşan bir *flavivirus* olan kene kaynaklı ensefalit virüsü (TBEV), non-spesifik semptomlar ile karakterize bir klinik tabloya neden olabileceği gibi daha spesifik bir durum olan ensefalit ve miyelit tablosu oluşturabilmektedir. Kırım-Kongo kanamalı ateşi (KKKA) ön tanısı ile yatırılarak takip edilen hastaların çoğu kene ile temas riski olan bölgelerden gelmektedir. Bu çalışmanın amacı TBEV'nin epidemiyolojisinin belirlenmesidir.

**Gereç ve Yöntem:** Sivas Cumhuriyet Üniversitesi Tıp Fakültesi Enfeksiyon Hastalıkları ve Klinik Mikrobiyoloji Anabilim Dalı servisinde KKKA ön tanısı ile Nisan-Eylül 2021 tarihleri arasında takip edilen 272 erişkin hasta çalışmaya dahil edildi. KKKA tanısı, Sağlık Bakanlığı Türkiye KKKA Bilimsel Kurulu tarafından oluşturulan kriterler kullanılarak tanımlandı. TBE seroprevalansını belirlemek amacıyla hasta serum örneklerinden ELISA yöntemi ile (Anti-TBE Virus ELISA (IgG) Euroimmun, Almanya) TBEV-IgG antikorları araştırıldı. Sonuçlar, hasta örneğinin ekstinksiyon değerinin kalibratör 2'nin ekstinksiyon değerine oranı hesaplanarak değerlendirilmiş ve bu oran 0.8'den küçük olarak saptandığında negatif, 0.8 ile 1.1 arasında ise ara değer, 1.1'den büyük saptandığında ise pozitif olarak kabul edilmiştir. Serum örneklerinde TBEV'ye karşı oluşmuş antikor saptanmamış hastalar seronegatif olarak değerlendirildi.

**Bulgular:** Çalışmaya alınan 272 hastanın yaş ortalaması ± standart sapma (SD) 49,46 ± 17,48 (Yaş aralığı: 18 -98) yıl olup 181'i (%66,5) erkek idi. Tüm hastaların TBEV antikor düzeyleri negatif olarak değerlendirildi. Hastaların ikamet ettiği iller Sivas, Giresun, Tokat, Yozgat ve Erzincan idi. Hastaların 204'ünde (%75) kene temas öyküsü bulunurken, bu sayı erkek hastalarda 143 (%79), kadın hastalarda ise 61 (%67) olarak saptandı.

**Sonuç:** Çalışmamızda TBEV'ye karşı oluşmuş antikor saptanmamış olması kene popülasyonunda TBEV'nin yokluğunu dolaylı yoldan ortaya koymuştur. Ancak Sivas ilinde kene popülasyonu üzerinde TBEV'nin varlığını saptamaya yönelik bir çalışma bulunmamaktadır ve çalışmamız bu konuda yapılmış ilk çalışma olma özelliğini taşımaktadır. Bununla birlikte, daha fazla seroepidemiolojik çalışmanın yapılması gerekmektedir.

**Anahtar Kelimeler:** Kene Kaynaklı Ensefalit virüs, Kırım Kongo Kanamalı Ateşi, ELISA

<sup>a</sup> dr.murtazaaz42@gmail.com

<sup>c</sup> caneroksuz05@gmail.com

<sup>e</sup> aysenurpektaş@cumhuriyet.edu.tr

<sup>g</sup> alibuyuktuna@gmail.com

<sup>b</sup> 0000-0003-3415-5927

<sup>d</sup> 0000-0002-3944-4608

<sup>f</sup> 0000-0001-5621-2844

<sup>h</sup> 0000-0001-6518-7361

<sup>b</sup> yasemincakir2553@gmail.com

<sup>d</sup> binnurkoksalsbagci@gmail.com

<sup>f</sup> tturan@cumhuriyet.edu.tr

<sup>h</sup> nelaldi61@yahoo.com

<sup>g</sup> 0000-0001-5510-3216

<sup>h</sup> 0000-0003-1323-3359

<sup>h</sup> 0000-0002-4223-1734

<sup>h</sup> 0000-0002-9515-770X

**How to Cite:** Öz M, Çakır Kıymaz Y, Öksüz C, Bağcı B, Pektaş AN, Turan T, Büyüktuna SA, Elaldi N. Investigation of The Prevalence of Tick-Borne Encephalitis Virus Antibodies In Patients With Preliminary Diagnosis of Crimean-Congo Hemorrhagic Fever, Cumhuriyet Medical Journal,2025;47(1):22-25

## Introduction

Crimean-Congo Hemorrhagic Fever (CCHF) is a zoonotic infection caused by the CCHF virus, which belongs to the *Nairovirus* genus within the *Nairoviridae* family.<sup>1</sup> The clinical presentation and outcomes of CCHF, which manifests as a hemorrhagic fever syndrome, vary widely. While 88% of infected individuals remain asymptomatic, symptomatic cases exhibit a spectrum of clinical manifestations ranging from mild illness, characterized by nonspecific symptoms such as fever, headache, myalgia, arthralgia, nausea, and vomiting, to severe conditions including major hemorrhages, hemodynamic instability, liver damage, and neurological disorders.<sup>2</sup> The CCHF virus is transmitted to humans via infected ticks (through tick bites or crushing of ticks) or through direct contact with the infected blood or tissues of viremic animals.<sup>3</sup>

Tick-borne encephalitis virus (TBEV), a member of the *Flavivirus* genus within the *Flaviviridae* family, is an RNA virus.<sup>4</sup> The virus can be transmitted via contact with ticks of the *Ixodes* species as well as through the consumption of unpasteurized dairy products from infected animals (e.g., goats). The disease was first described in Austria in 1931, and its causative agent was isolated in the eastern regions of Russia in 1937.<sup>5</sup> Annually, over 10,000 cases of the disease are reported, making TBEV the second most prevalent neurotropic flavivirus worldwide.<sup>6</sup> Furthermore, the number of cases has been steadily increasing in recent years.<sup>6</sup> The disease typically progresses in two phases. The first phase involves nonspecific symptoms such as fever and headache, followed by an asymptomatic period. The second phase is characterized by neurological complications, including encephalitis and myelitis.<sup>7</sup>

The aim of this study is to investigate the seroprevalence of TBEV, another tick-borne infection, among patients hospitalized with a preliminary diagnosis of CCHF.

## Materials and Methods

This study is a retrospective cohort study. The study included patients aged 18 years and older who were hospitalized in the Department of Infectious Diseases and Clinical Microbiology at Sivas Cumhuriyet University Faculty of Medicine between April 1, 2021, and September 31, 2021. Ethical approval for the study was granted by the Clinical Research Ethics Committee of Sivas Cumhuriyet University on April 19, 2023 (approval number: 2023-04/61). Cases suspected of Crimean-Congo hemorrhagic fever (CCHF) were defined using the CCHF case definition criteria developed by the Turkish Ministry of Health's Scientific Committee on CCHF. Patients presenting with at least two symptoms such as fever, headache, widespread body pain, arthralgia, fatigue, diarrhea, and bleeding, as well as having visited or resided in an endemic area for CCHF within the last two weeks, or having a history of tick exposure with thrombocytopenia ( $<1.5 \times 10^5/\text{mm}^3$ ) and/or leukopenia ( $<4 \times 10^3/\text{mm}^3$ ), were considered suspected cases of CCHF.<sup>8</sup> The diagnosis

of CCHF was confirmed by the Turkey Republic Ministry of Health's General Directorate of Public Health through the detection of anti-immunoglobulin M antibodies and Crimean-Congo Hemorrhagic Fever Virus (CCHFV) Polymerase Chain Reaction (PCR) in patient serum samples.

Epidemiological data for the included volunteers, such as age, gender, occupation, clinical and routine laboratory data, and history of tick attachment, were recorded individually for each volunteer. Serum samples collected on the day of hospitalization for diagnostic purposes (0.5 ml each) were stored at  $-80^\circ\text{C}$ . The serum samples to be used in the study have been maintained under proper conditions up to the present, with no thawing or power interruptions during storage. On the day of testing, serum samples were removed 2 hours prior to application and allowed to thaw at room temperature. All reagents were brought to room temperature ( $+18^\circ\text{C}$  to  $+25^\circ\text{C}$ ) 30 minutes before use. The washing solution was diluted with water (1 part washing solution to 9 parts distilled water). Patient samples were diluted 1:101 with sample buffer. TBEV-IgG antibodies were investigated using the ELISA method (Anti-TBE Virus ELISA (IgG) (EI 2661-9601 G), Euroimmun, Germany (Lübeck)). The results were evaluated semi-quantitatively by calculating the ratio of the extinction value of the control or patient sample to the extinction value of calibrator 2. A ratio less than 0.8 was considered negative, a ratio between 0.8 and 1.1 was considered an intermediate value, and a ratio greater than 1.1 was considered positive.

Epidemiological data including age (years), gender, clinical symptoms and signs at hospital admission, routine laboratory test results, history of tick exposure, and occupation of the patients were collected from electronic patient records and entered into Microsoft Excel (Microsoft Office Version 365, USA; URL: <https://www.office.com/>). Statistical analysis was performed using the Statistical Package for Social Sciences (SPSS) version 23.0 (IBM® SPSS®, Armonk, New York, USA; URL: <https://www.ibm.com/products/spss-statistics>). Age (years) data were reported as mean and standard deviation (SD), while gender, history of tick exposure, and serological results were reported as n (%). The normality of continuous variables was tested using the Kolmogorov-Smirnov and Shapiro-Wilk tests. Anti-TBE IgG antibody levels determined by ELISA were recorded as optical density (OD) values for each patient.

## Results

A total of 272 patients were included in the study, with 181 (66.5%) male and 91 (33.5%) female, with a mean age of  $49.46 \pm 17.48$  years. A history of tick exposure was present in 204 (75%) of the patients. Among the male patients, 143 (79%) had a history of tick exposure, while 61 (67%) of the female patients had a similar history. Of the 272 patients included in the study, 250 were from Sivas, 15 from Giresun, 4 from Yozgat, 2 from Tokat, and 1 from Erzincan (Figure 1). Of the 272 patients (82.7%) admitted with a preliminary diagnosis of CCHF, 225 tested

positive for CCHF PCR, while 47 (17.3%) had negative results. The majority of the patients, 223 (82%), were engaged in farming and animal husbandry, and 97% had a history of living in or visiting rural areas. The history of tick

exposure and CCHF PCR results of the patients are detailed in Table 1. All patients' TBEV antibody levels were found to be negative.



Figure 1: Distribution of Patients with Preliminary CCHF Diagnosis by Provinces

Table 1: Gender distribution, tick exposure, CCHF-PCR results, and TBEV serology data of Patients by Provinces

	Number of patients by provinces n (%)	Gender distribution n (%)	History of tick exposure n (%)	CCHF-PCR results n (%)	TBEV serology n (%)
Sivas	250 (%92)	Male:163 (%65.2)	Yes: 184 (%73.6)	Positive: 207 (%82.8)	Negative: 250 (%100)
Giresun	15 (%5,6)	Male: 12 (%80)	Yes: 14 (%93.3)	Positive: 14 (%93.3)	Negative: 15 (%100)
Yozgat	4 (%1,4)	Male: 4 (%100)	Yes: 4 (%100)	Positive: 3 (%75)	Negative: 4 (%100)
Tokat	2 (%0.7)	Male: 1 (%50)	Yes: 1 (%50)	Positive: 1 (%50)	Negative: 2 (%100)
Erzincan	1 (%0.3)	Male: 1 (%100)	Yes: 1 (%100)	Positive: 0 (%0)	Negative: 1 (%100)

CCHFV-PCR: Crimean-Congo hemorrhagic fever virus polymerase chain reaction  
 TBEV: Tick-borne encephalitis virus

Discussion

TBEV (Tick-borne encephalitis virus) is a neurotropic virus belonging to the *Flavivirus* genus of the *Flaviviridae* family.<sup>4</sup> First discovered in 1931, this virus is endemic in Central, Eastern, and Northern Europe, as well as in Northeastern Asia.<sup>9</sup> The existence of TBEV in nature is primarily maintained through transmission between wild mammalian hosts and migratory birds via ixodid ticks.<sup>10</sup> The clinical presentation of the virus varies depending on its subtype, but it typically starts with nonspecific symptoms such as fatigue, headache, neck pain, high fever, and vomiting, progressing into a two-phase clinical course.<sup>7</sup> In 20-30% of patients, a second phase follows an asymptomatic period of 2-10 days, leading to neurological involvement such as meningitis, encephalitis, myelitis, or radiculitis.<sup>11</sup>

CCHFV, belonging to the *Orthonairovirus* genus of the *Nairoviridae* family under the *Bunyvirales* order, was first identified in 1944 in Crimea and has since been reported

in more than 35 countries.<sup>12</sup> Similar to TBEV, the primary route of transmission for CCHF virus is through tick attachment, which serves as the vector for the virus.<sup>11</sup> In addition to tick transmission, CCHF can also spread through contact with tissues, feces, or secretions from infected animals or humans.<sup>3</sup> The initial symptoms of CCHF, which leads to viral hemorrhagic fever, can overlap with those of TBEV infection, which is transmitted through tick bites. Therefore, in this study, the presence of TBEV was investigated in patients who were initially diagnosed with CCHF.

TBEV is endemic in many regions of Europe and Asia; however, there is limited data on TBEV activity in Turkey.<sup>13-15</sup> The first evidence of TBEV infection in Turkey showed an IgG positivity rate of 10.5%.<sup>13</sup> A study evaluating TBEV exposure in 181 healthy blood donors and the impact of TBEV on central nervous system infections in Central/North Anatolia analyzed 2454 serum samples, finding a seropositivity rate of 1.9%.<sup>14</sup> Another

study investigating TBEV seropositivity in 278 individuals with tick contact identified IgG positivity in 4 patients (1.4%).<sup>15</sup> Except for one patient, all participants in this study were from the Central Anatolia region. In a study similar to ours, where TBEV seropositivity was assessed in patients with suspected CCHF, one patient had IgM positivity, and seven others had IgG positivity.<sup>16</sup> In our study, TBEV seropositivity was investigated in patients admitted with a preliminary diagnosis of CCHF, but all results were negative. This supports the notion that TBEV is not a significant threat in our region.

TBEV spans a wide area, including Northern Asia and Europe, and has three subtypes. The European subtype is transmitted by *Ixodes ricinus*, and the Far Eastern and Siberian subtypes are transmitted by *Ixodes persulcatus*.<sup>6,17</sup> The mortality rate for the European and Siberian subtypes is approximately 1–3%, while the Far Eastern subtype's mortality rate can rise to 20–40%.<sup>17,18</sup> Only the European subtype, transmitted by *Ixodes ricinus*, is found in Turkey. However, no outbreaks have been reported thus far. The presence of the *Ixodes ricinus* tick responsible for transmitting the European subtype was reported in wild animals in our region in 2011 and 2012.<sup>19</sup> However, there have been no reported TBE cases in our region to date. In our study, 204 out of 272 patients (75%) with a suspected CCHF diagnosis had tick contact. However, since the blood samples from these patients were collected during the acute phase before the formation of antibodies, no positivity was detected, which may explain the negative results.

In conclusion, the presence of the tick vector for TBEV in our region and the absence of antibodies to TBEV in our study support the idea that TBEV is not a significant threat in our region. However, further studies are needed to explore the presence and epidemiology of the virus in Turkey.

#### Acknowledge

This study was supported by Sivas Cumhuriyet University Scientific Research Projects Board (Project No: T-2022-988)

This study was produced from the first author's specialty thesis.

#### Authorship Contribution

Concept/Hypothesis: MÖ, NE

Design: MÖ, YÇK, NE

Data Collection/Data Processing: MÖ, ANP, BB, TT

Data Analysis: NE, TT

Manuscript Preparation: MÖ, NE, YÇK, SAB, CÖ

#### Conflicts of interest

There are no conflicts of interest in this work.

#### Ethical Approval Statement

Ethical approval for the study was granted by the Clinical Research Ethics Committee of Sivas Cumhuriyet University on April 19, 2023 (approval number: 2023-04/61).

## References

- 1- Büyüktuna S.A, Bolat S, Doğan K, Çakır Y, Doğan H.O. Assessment of Serum Beta 2-Microglobulin Levels in Crimean-Congo Hemorrhagic Fever Patients: Implications for Immune Activation and Disease Pathogenesis. Cumhuriyet Science Journal, 2024;45(2):338-42.
- 2- Baysal AÇ, Kıymaz YÇ, Şahin NÖ, Bakır M. Investigation of Long Noncoding RNA-NRAV and Long Noncoding RNA-Lethe Expression in Crimean-Congo Hemorrhagic Fever. J Med Virol. 2024 Dec;96(12):e70142.
- 3- Büyüktuna SA, Yerlitaş Sİ, Zararsız GE, Doğan K, Kablan D, Bağcı G, et al. Exploring free amino acid profiles in Crimean-Congo hemorrhagic fever patients: Implications for disease progression. J Med Virol. 2024;96(5):e29637.
- 4- Schneider H. Über epidemische acute'meningitis serosa'. Wien. Klin. Wochenschr. 1983; 44: 350-352.
- 5- Kunz C, Heinz FX. Tick-borne encephalitis. Vaccine. 2003;21(1):1-2.
- 6- Lindquist, Lars, and Olli Vapalahti. Tick-borne encephalitis. The Lancet. 2008;371:1861-71.
- 7- Shayan S, Bokaeian M, Shahrivar MR, Chinikar S. Crimean-Congo Hemorrhagic Fever. Lab Med. 2015;46(3):180-9.
- 8- Leblebicioglu H, Bodur H, Dokuzoguz B, Elaldi N, Guner R, Koksali I, et al. Case management and supportive treatment for patients with Crimean-Congo hemorrhagic fever. Vector Borne Zoonotic Dis. 2012 Sep;12(9):805-11. doi: 10.1089/vbz.2011.0896.
- 9- Lani R, Moghaddam E, Haghani A, Chang LY, AbuBakar S, Zandi K. Tick-borne viruses: a review from the perspective of therapeutic approaches. Ticks Tick Borne Dis. 2014 Sep;5(5):457-65. doi: 10.1016/j.ttbdis.2014.04.001.
- 10- Mansfield KL, Johnson N, Phipps LP, Stephenson JR, Fooks AR, Solomon T. Tick-borne encephalitis virus - a review of an emerging zoonosis. J Gen Virol. 2009;90(8):1781-94.
- 11- Süss J. Epidemiology and ecology of TBE relevant to the production of effective vaccines. Vaccine. 2003;21:19-35.
- 12- Ergonul O. Crimean-Congo hemorrhagic fever virus: new outbreaks, new discoveries. Curr Opin Virol. 2012;2(2):215-20.
- 13- Ergünay K, Ozer N, Us D, Ozkul A, Simsek F, Kaynas S, Ustacelebi S. Seroprevalence of West Nile virus and tick-borne encephalitis virus in southeastern Turkey: first evidence for tick-borne encephalitis virus infections. Vector Borne Zoonotic Dis. 2007 Summer;7(2):157-61.
- 14- Uyar Y, Akçalı A, Çarhan A, Özkaya E, Ertek M. Türkiye'de Kene Isırığı Öykülü Olgularda Tick-Borne Encephalitis Virüsünün Seroprevalansı. 2007;64(2):21-25
- 15- Ergünay K, Saygan MB, Aydoğan S, Litzba N, Şener B, Lederer S, et al. Confirmed Exposure to Tick-Borne Encephalitis Virus and Probable Human Cases of Tick-Borne Encephalitis in Central/Northern Anatolia, Turkey. Zoonoses and Public Health. 2011 May;58(3):220-7.
- 16- Esen B, Gozalan A, Coplu N, Tapar FS, Uzun R, Aslan T, et al. The presence of tick-borne encephalitis in an endemic area for tick-borne diseases, Turkey. Trop Doct. 2008 ;38(1):27-8.
- 17- Gritsun T, Lashkevich V, Gould E. Tick-borne encephalitis. Antiviral Research. 2003 Jan;57(1-2):129-46.
- 18- Dorrbecker B, Dobler G, Spiegel M, Hufert FT. Tickborne encephalitis virus and the immune response of the mammalian host. Travel Med Infect Dis. 2010;8,213-222.
- 19- Bursali A, Keskin A, Şimşek E, Keskin A, Tekin S. A survey of ticks (Acari: Ixodida) infesting some wild animals from Sivas, Turkey. Exp Appl Acarol. 2015;66(2):293-9.



## Prevalence of Dyslipidemia at Onset and During Follow-Up in Pediatric Patients with Type 1 Diabetes Mellitus

Ayça Bilge Sönmez<sup>1,a,\*</sup>, Filiz Tütüncüler<sup>2,b</sup>

<sup>1</sup> Trakya University, School of Medicine, Department of Pediatrics, Edirne, Türkiye

<sup>2</sup> Trakya University, School of Medicine, Department of Pediatrics and Pediatric Endocrinology Unit, Edirne, Türkiye

\*Corresponding author

### Research Article

#### History

Received: 11/02/2025

Accepted: 13/03/2025

#### Copyright



This work is licensed under  
Creative Commons Attribution 4.0  
International License

### ABSTRACT

**Objectives:** This study assessed the prevalence of dyslipidemia in pediatric patients with type 1 diabetes mellitus (T1DM) at diagnosis and after one year, examining the effects of glycemic control on lipid levels.

**Material and methods:** A retrospective analysis was conducted on 56 T1DM patients (30 males, 26 females) aged 10-18 years. These patients were monitored every three months for at least one year. Data on lipid profiles and glycemic control were collected at baseline and after one year.

**Results:** Dyslipidemia prevalence significantly decreased from 60.7% at baseline to 26.8% after one year ( $p < 0.001$ ). At follow-up, hemoglobin A1c (HbA1c), low-density lipoprotein (LDL), and triglyceride (TG) levels were significantly lower compared to baseline ( $7.95 \pm 1.73\%$  vs.  $13.45 \pm 2.45\%$ ,  $84.07 \pm 27.55$  mg/dl vs.  $94.84 \pm 27.87$  mg/dl, and  $78.75 \pm 29.93$  mg/dl vs.  $105.98 \pm 58.95$  mg/dl, respectively) ( $p < 0.001$ ,  $p = 0.007$ ,  $p = 0.001$ ). Total cholesterol (TC) also decreased, though the difference was near significance ( $151.20 \pm 25.55$  mg/dl vs.  $159.79 \pm 29.78$  mg/dl,  $p = 0.05$ ). High-density lipoprotein (HDL) levels increased significantly ( $55.60 \pm 11.10$  mg/dl vs.  $49.63 \pm 13.46$  mg/dl,  $p < 0.001$ ). Females had higher HDL levels than males ( $60.08 \pm 12.37$  mg/dl vs.  $51.71 \pm 8.24$  mg/dl,  $p = 0.004$ ). HbA1c levels showed a positive correlation with TC, LDL, and TG, and a negative correlation with HDL.

**Conclusion:** This study highlights a significant reduction in dyslipidemia in pediatric T1DM patients after one year, linked to improved glycemic control. Effective HbA1c management is crucial for better lipid profiles and reduced cardiovascular risk.

**Keywords:** type 1 diabetes mellitus, dyslipidemia, childhood

## Tip 1 Diyabetes Mellitus Olan Pediatrik Hastalarda Tanı ve İzlemede Dislipidemi Prevalansı

### Araştırma Makalesi

#### Süreç

Gelis: 11/02/2025

Kabul: 13/03/2025

#### Telif Hakkı



Bu Çalışma Creative Commons Atf  
4.0 Uluslararası Lisansı  
Kapsamında Lisanslanmıştır.

### ÖZET

**Amaç:** Bu çalışmada, tip 1 diyabetes mellituslu (T1DM) pediatrik hastalarda tanı anı ile bir yıllık izlem sonundaki dislipidemi prevalansı değerlendirildi ve glisemik kontrolün lipid seviyeleri üzerindeki etkileri incelendi.

**Materyal ve yöntem:** 10-18 yaş aralığındaki 56 (30 erkek, 26 kız) T1DM hastasının verileri retrospektif olarak analiz edildi. En az bir yıl boyunca her üç ayda bir görülen hastaların başlangıçtaki ve bir yıl sonraki lipid profilleri ve glisemik kontrol ile ilgili verileri değerlendirildi.

**Bulgular:** Dislipidemi prevalansı başlangıçtaki %60.7 iken bir yıl sonra anlamlı bir azalma göstererek %26.8'e geriledi ( $p < 0.001$ ). Takipte hemoglobin A1c (HbA1c), düşük yoğunluklu lipoprotein (LDL) ve trigliserid (TG) düzeyleri başlangıç değerlerine göre anlamlı azalma gösterdi ( $7.95 \pm 1.73\%$ 'e karşı  $13.45 \pm 2.45$ ,  $84.07 \pm 27.55$  mg/dl'ye karşı  $94.84 \pm 27.87$  mg/dl ve  $78.75 \pm 29.93$  mg/dl'ye karşı  $105.98 \pm 58.95$  mg/dl) ( $p < 0.001$ ,  $p = 0.007$ ,  $p = 0.001$ ). Total kolesterol (TK) değerlerinde istatistiksel anlamlılık sınırında azalma görüldü ( $151.20 \pm 25.55$  mg/dl'ye karşı  $159.79 \pm 29.78$  mg/dl,  $p = 0.05$ ). Yüksek yoğunluklu lipoprotein (HDL) seviyeleri anlamlı artış gösterdi ( $55.60 \pm 11.10$  mg/dl'ye karşı  $49.63 \pm 13.46$  mg/dl,  $p < 0.001$ ). Kızların HDL seviyeleri erkeklerden daha yüksekti ( $60.08 \pm 12.37$  mg/dl'ye karşı  $51.71 \pm 8.24$  mg/dl,  $p = 0.004$ ). HbA1c seviyeleri TK, LDL ve TG seviyeleri ile pozitif korelasyon, HDL ile negatif korelasyon gösterdi.

**Sonuç:** Bu çalışma, pediatrik T1DM hastaların bir yıllık izleminde dislipidemi prevalansındaki azalmanın, iyileşen glisemik kontrolle bağlantılı olduğunu vurgulamaktadır. Daha iyi lipid profilleri ve kardiyovasküler riskin azalması için etkili HbA1c yönetimi çok önemlidir.

**Anahtar Kelimeler:** tip 1 diyabetes mellitus, dislipidemi, çocukluk çağı

## Introduction

The autoimmune disease referred to as type 1 diabetes mellitus (T1DM) is defined by the body's immune system attacking beta cells in the pancreas, which causes little or no insulin production. In genetically predisposed people with particular human leukocyte antigen (HLA) types, this process generally begins with viral infections, chemical agents, or toxic exposures. The most common chronic endocrine condition in children is type 1 diabetes.<sup>1</sup> T1DM is responsible for 80–95% of childhood-onset diabetes cases. There are variations in incidence rates between nations and within a single country, ranging from 2 to 50 cases per 100,000.<sup>2</sup>

Microvascular problems, such as retinopathy, nephropathy, and neuropathy, and macrovascular disorders, like atherosclerosis and coronary heart disease, are the two categories of long-term complications of T1DM. The growing number of cases of T1DM in adolescents and the increasingly early ages at which it is diagnosed are raising concerns that this may result in a greater burden of the illness and a greater occurrence of early-onset macrovascular consequences.<sup>3-5</sup> Vascular and atherosclerotic heart conditions are the leading causes of death in diabetics.<sup>6</sup> Atherosclerosis remains the most common cause of morbidity and mortality in developed cultures. High plasma levels of total cholesterol (TC), low-density lipoprotein (LDL), and triglycerides (TGs), as well as lower concentrations of high-density lipoprotein (HDL), constitute significant modifiable risk factors for atherothrombotic vascular disorders.<sup>7</sup>

While T1DM by itself increases the risk of cardiovascular diseases (CVDs), dyslipidemia increases the risk even more. According to numerous studies, elevated serum cholesterol levels are the initial indication of atherosclerosis in children.<sup>8</sup> A risk factor for coronary artery disease has been found to be dyslipidemia in children and adolescents with T1DM. For this reason, T1DM patients are advised to check their lipid levels frequently in order to lower the risk of CVD.<sup>9,10</sup> Cardiovascular risk factors, including dyslipidemia, hypertension, and elevated body mass index (BMI), are more commonly linked to poor glycemic control in children with T1DM. Furthermore, even when blood pressure and BMI are normal, a rise in the frequency of dyslipidemia has been reported.<sup>11,12</sup>

The purpose of this study was to find out the prevalence of dyslipidemia in T1DM patients at the time of diagnosis and at the one-year follow-up. The study also sought to examine variations in lipid levels by maintaining glycemic control throughout the follow-up period.

## Materials and Methods

56 children between the ages of 10 and 18 who were diagnosed with T1DM at a pediatric endocrinology outpatient clinic between 2006 and 2013 and who received follow-up visits every three months for a minimum of a year were included in the study. Informed consent was not taken because the study was retrospective observational and used anonymous clinical data. This study was approved by the ethics committee of Trakya University School of Medicine (TÜTF-TÜBAPK 2015-134).

In this study, the medical records of patients with T1DM who were being followed-up in our pediatric endocrinology outpatient clinic were retrospectively reviewed. The following

individuals were not included in the study out of the 286 T1DM patients: five patients (1.8%) with diseases affecting lipid metabolism (hypothyroidism), one patient (0.3%) taking antilipidemic medication, 75 patients (26.3%) diagnosed at an external center with missing initial data, 77 patients (24.9%) not attending routine follow-ups, and 72 patients (25.2%) not in the appropriate age range. As a result, the study comprised 56 patients who met the criteria for inclusion.

The patients' baseline and one-year follow-up clinical and laboratory data were taken from their medical records. Age, gender, age at diagnosis of T1DM, height standard deviation score (SDS), weight SDS, BMI SDS, prevalence of overweight/obesity, pubertal status, clinical presentation (diabetic ketoacidosis, diabetic ketosis, or hyperglycemia) at diagnosis, hemoglobin A1c (HbA1c), HDL, LDL, TG, and TC levels, frequency of dyslipidemia, glycemic control status, 24-hour urine microalbumin levels, electromyography (EMG), and fundus examination results were among the recorded data. Using the International Society for Pediatric and Adolescent Diabetes (ISPAD) standards, dyslipidemia was diagnosed when fasting venous blood HDL levels were less than 40 mg/dL, LDL levels were greater than 100 mg/dL, or TG levels were greater than 150 mg/dL.<sup>13</sup> Glycemic control was used for sorting patients into three groups: good (HbA1c < 7.5%), moderate (7.5% ≤ HbA1c < 9%), and bad (HbA1c ≥ 9%).<sup>13</sup> The diagnosis of neuropathy includes changes in heart rate, postural blood pressure, or reduced nerve conduction velocity on the EMG. A 24-hour urine microalbumin level of 30–300 mg/day was used to identify microalbuminuria, and fundus photography and/or direct ophthalmoscopy were used to diagnose retinopathy at an outpatient clinic for eye diseases.<sup>13-15</sup>

BMI values were classified based on percentile ranges: normal weight (5th–85th percentile), overweight (85th–95th percentile), obesity (≥95th percentile), and underweight (<5th percentile). For Turkish children, measurements of body mass index (BMI) were based on percentile curves that were specific to age and gender.<sup>16</sup> Tanner staging was used to stage pubertal development; for boys, the onset of puberty was defined as a testicular volume of 4 mL, while for girls, the initiation of breast development.<sup>17</sup>

A SECA scale (GMBH & CO KG, Hamburg, Germany) was used to measure the children's body weight at admission. They were fasted and only wearing their underwear. A 0.1 cm precision Harpenden stadiometer (Holtain Limited, Crymych, Dyfed, U.K.) was used to measure height. Following a 12-hour fast, blood samples were drawn, and once glycemic control was achieved, measurements were made. Using column chromatography on a Premier Hb9210 device, HbA1c levels were determined; the typical range is 3.6% to 5.8%. A Bayer Advia Reagent Packs device was used to assess the levels of TC, LDL, TG, and HDL in accordance with the standard value ranges suggested by ISPAD guidelines.<sup>13</sup>

## Statistical Analysis

SPSS version 19.0, licensed under license number 10240642, was used to carry out statistical analysis of the study's findings. The mean ± standard deviation (SD) is used to describe continuous variables, whereas the number of cases (n) and percentages (%) are used to describe categorical variables. The Shapiro-Wilks and Levene's tests were used to evaluate the homogeneity of variances and the normality of the distribution, respectively. The independent samples t-test



was employed to assess group differences and the chi-squared test for categorical variables. The means of two related groups were compared using the dependent samples t-test. The McNemar test and the marginal homogeneity test were used for categorical dependent variables. Pearson's correlation coefficient was used to examine the relationships between the variables. A two-sided p-value of less than 0.05 was considered statistically significant.

**Results**

The study comprised fifty-six T1DM patients, aged ten to eighteen (30 males and 26 females). 78.6% of the patients were pubertal, and their average age was 12.4 ± 1.5 years. The mean decimal age, height SDS, weight SDS, BMI SDS, frequency of being overweight or obese, pubertal status, clinical presentations (diabetic ketoacidosis, diabetic ketosis, or hyperglycemia), laboratory results (HbA1c, TC, HDL, LDL, TG), and frequency of dyslipidemia did not significantly differ between male and female patients based on the baseline data at the time of T1DM diagnosis (p > 0.05). In neither group were microvascular problems found (Table 1).

Fifty-three patients (94.6%) were at the pubertal stage at the one-year follow-up. The mean height SDS, weight SDS, BMI

SDS, frequency of being overweight or obese, pubertal status, mean levels of HbA1c, TC, LDL, and TG, frequency of dyslipidemia, and glycemic control status did not differ significantly between male and female patients (p > 0.05). Nonetheless, the mean HDL levels of females were significantly greater than those of males (p < 0.05). In neither group were microvascular problems found (Table 2).

At the one-year follow-up, mean weight SDS, BMI SDS, and HDL values were significantly higher, while mean HbA1c, LDL, and TG levels were significantly lower than baseline (p < 0.05). TC also decreased, though the difference was near significance (p = 0.05). Dyslipidemia prevalence also decreased from 60.7% to 26.8% (p < 0.05), whereas mean height SDS and overweight/obesity prevalence showed no significant change (p > 0.05) (Table 3).

Using pooled data, correlations between patients' BMI SDS, TC, HDL, LDL, and TG values and their HbA1c levels at baseline and at the one-year follow-up were examined. HbA1c levels had a significant negative correlation with HDL levels (r = -0.240, p = 0.011) and a significant positive correlation with TC, LDL, and TG levels (r = 0.269, p = 0.004; r = 0.314, p = 0.001; and r = 0.344, p < 0.001, respectively). There was no significant correlation between HbA1c levels and BMI SDS (r = -0.122, p = 0.200).

**Table 1. Clinical and Laboratory Characteristics of the Study Subjects at Baseline (Time of Type 1 Diabetes Mellitus Diagnosis)**

	Total (n=56)	Male (n=30)	Female (n=26)	p
<b>Age (decimal)</b>	12.36±1.49	12.67±1.58	12.01±1.34	0.099 <sup>a</sup>
<b>Height SDS</b>	0.31±1.07	0.37±0.97	0.24±1.20	0.641 <sup>a</sup>
<b>Weight SDS</b>	-0.39±1.05	-0.24±1.06	-0.57±1.03	0.246 <sup>a</sup>
<b>BMI SDS</b>	-0.18±1.48	-0.17±1.60	-0.20±1.35	0.947 <sup>a</sup>
<b>Overweight / obese</b>	9 (16.1)	5 (16.7)	4 (15.4)	0.896 <sup>b</sup>
<b>Pubertal status</b>				
Prepubertal	12 (21.4)	9 (30.0)	3 (11.5)	0.093 <sup>b</sup>
Pubertal	44 (78.6)	21 (70.0)	23 (88.5)	
<b>Clinical presentation</b>				
Diabetic ketoacidosis	31 (55.4)	15 (50.0)	16 (61.5)	0.416 <sup>b</sup>
Diabetic ketosis	20 (35.7)	13 (43.3)	7 (26.9)	
Hyperglycemia	5 (8.9)	2 (6.7)	3 (11.6)	
<b>HbA1c %</b>	13.45±2.45	12.97±2.18	14.02±2.66	0.112 <sup>a</sup>
<b>TC (mg/dl)</b>	159.79±29.78	157.43±27.04	162.50±32.99	0.530 <sup>a</sup>
<b>HDL (mg/dl)</b>	49.63±13.46	47.08±13.56	52.58±12.99	0.129 <sup>a</sup>
<b>LDL (mg/dl)</b>	94.84±27.87	93.62±21.33	96.25±34.31	0.728 <sup>a</sup>
<b>TG (mg/dl)</b>	105.98±58.95	103.80±62.95	108.50±55.11	0.769 <sup>a</sup>
<b>Dyslipidemia</b>	34 (60.7)	18 (60.0)	16 (61.5)	0.906 <sup>b</sup>
<b>Glycemic control</b>				
Good	0 (0.0)	0 (0.0)	0 (0.0)	
Moderate	1 (1.8)	0 (0.0)	1 (3.8)	0.464 <sup>b</sup>
Poor	55 (98.2)	30 (100.0)	25 (96.2)	
<b>Microvascular complications</b>				
Retinopathy	0 (0.0)	0 (0.0)	0 (0.0)	-
Microalbuminuria	0 (0.0)	0 (0.0)	0 (0.0)	-
Neuropathy	0 (0.0)	0 (0.0)	0 (0.0)	-

SDS: Standard deviation score, BMI: Body mass index, HbA1c: Hemoglobin A1c, TC: Total cholesterol, HDL: High-density lipoprotein, LDL: Low-density lipoprotein, TG: Triglyceride.

Continuous variables are reported as the mean ± standard deviation, and categorical variables are expressed as the number of cases (n) and percentage (%). <sup>a</sup>Independent samples t-test; <sup>b</sup>Chi-square test.

**Table 2.** Clinical and Laboratory Characteristics of the Study Subjects at 1-Year Follow-Up

	Total (n=56)	Male (n=30)	Female (n=26)	p
Age (decimal)	13.36±1.49	13.67±1.58	13.01±1.34	0.101 <sup>a</sup>
Height SDS	0.36±0.93	0.45±0.87	0.27±1.01	0.484 <sup>a</sup>
Weight SDS	0.14±1.15	0.07±1.13	0.21±1.20	0.664 <sup>a</sup>
BMI SDS	0.14±1.12	0.24±1.27	0.03±0.93	0.486 <sup>a</sup>
Overweight / obese	13 (23.2)	7 (23.3)	6 (23.1)	0.982 <sup>b</sup>
<b>Pubertal status</b>				
Prepubertal	3 (5.4)	2 (6.7)	1 (3.8)	0.640 <sup>b</sup>
Pubertal	53 (94.6)	28 (93.3)	25 (96.2)	
HbA1c %	7.95±1.73	7.95±1.72	7.95±1.78	0.999 <sup>a</sup>
TC (mg/dl)	151.20±25.55	147.20±21.99	155.81±28.88	0.212 <sup>a</sup>
HDL (mg/dl)	55.60±11.10	51.71±8.24	60.08±12.37	<b>0.004<sup>a</sup></b>
LDL (mg/dl)	84.07±27.55	82.18±22.09	86.26±33.09	0.585 <sup>a</sup>
TG (mg/dl)	78.75±29.93	82.40±36.97	74.54±18.72	0.331 <sup>a</sup>
Dyslipidemia	15 (26.8)	8 (26.7)	7 (26.9)	0.983 <sup>b</sup>
<b>Glycemic control</b>				
Good	26 (46.4)	14 (46.7)	12 (46.1)	
Moderate	17 (30.4)	7 (23.3)	10 (38.5)	0.312 <sup>b</sup>
Poor	13 (23.2)	9 (30.0)	4 (15.4)	
<b>Microvascular complications</b>				
Retinopathy	0 (0.0)	0 (0.0)	0 (0.0)	-
Microalbuminuria	0 (0.0)	0 (0.0)	0 (0.0)	-
Neuropathy	0 (0.0)	0 (0.0)	0 (0.0)	-

SDS: Standard deviation score, BMI: Body mass index, HbA1c: Hemoglobin A1c, TC: Total cholesterol, HDL: High-density lipoprotein, LDL: Low-density lipoprotein, TG: Triglyceride.

Continuous variables are reported as the mean ± standard deviation, and categorical variables are expressed as the number of cases (n) and percentage (%).

<sup>a</sup>Independent samples t-test; <sup>b</sup>Chi-square test.

**Table 3.** Comparison of The Baseline and 1-Year Follow-Up Clinical Data of the Study Subjects

	Baseline (n=56)	Follow-up (n=56)	p
Height SDS	0.31±1.07	0.36±0.93	0.426 <sup>a</sup>
Weight SDS	-0.39±1.05	0.14±1.15	<b>&lt;0.001<sup>a</sup></b>
BMI SDS	-0.18±1.48	0.14±1.12	<b>0.029<sup>a</sup></b>
Overweight / obese	9 (16.1)	13 (23.2)	0.219 <sup>b</sup>
<b>Pubertal status</b>			
Prepubertal	12 (21.4)	3 (5.4)	<b>0.012<sup>b</sup></b>
Pubertal	44 (78.6)	53 (94.6)	
HbA1c %	13.45±2.45	7.95±1.73	<b>&lt;0.001<sup>a</sup></b>
TC (mg/dl)	159.79±29.78	151.20±25.55	0.050 <sup>a</sup>
LDL (mg/dl)	94.84±27.87	84.07±27.55	<b>0.007<sup>a</sup></b>
HDL (mg/dl)	49.63±13.46	55.60±11.10	<b>&lt;0.001<sup>a</sup></b>
TG (mg/dl)	105.98±58.95	78.75±29.93	<b>0.001<sup>a</sup></b>
<b>Dyslipidemia</b>			
TC > 200 (mg/dl)	4 (7.1)	3 (5.4)	1.000
LDL > 100 (mg/dl)	23 (41.1)	11 (19.6)	<b>0.012</b>
HDL < 40 (mg/dl)	16 (28.6)	5 (8.9)	<b>0.003</b>
TG > 150 (mg/dl)	12 (21.4)	2 (3.6)	<b>0.002</b>
<b>Glycemic control</b>			
Good	0 (0.0)	26 (46.4)	
Moderate	1 (1.8)	17 (30.4)	<b>&lt;0.001<sup>c</sup></b>
Poor	55 (98.2)	13 (23.2)	

SDS: Standard deviation score, BMI: Body mass index, HbA1c: Hemoglobin A1c, TC: Total cholesterol, HDL: High-density lipoprotein, LDL: Low-density lipoprotein, TG: Triglyceride.

Continuous variables are reported as the mean ± standard deviation, and categorical variables are expressed as the number of cases (n) and percentage (%). <sup>a</sup>Dependent samples t-test; <sup>b</sup>McNemar test; <sup>c</sup>Marginal homogeneity test.

## Discussion

The findings of our study revealed a noteworthy change in lipid profiles with improved glycemic control over a one-year period, as well as a high prevalence of dyslipidemia among newly diagnosed young T1DM patients. 60.7% of the children with T1DM had dyslipidemia at baseline, and 98.2% had poor glycemic control. The findings of earlier investigations, which reported comparable early clinical and metabolic presentations in pediatric T1DM patients, are consistent with the high frequency of dyslipidemia and poor glycemic control.<sup>9,18</sup> Significant improvements were seen in the year prior to the follow-up: the rate of dyslipidemia dropped to 26.8%, and lipid levels improved dramatically with glycemic control. Since poor glycemic control has been linked to an increase in lipid abnormalities and cardiovascular risks, these changes are crucial.<sup>11,19</sup>

Glycemic control status and the prevalence of dyslipidemia did not significantly differ between male and female patients at follow-up. Yet when compared to males, females' HDL levels were noticeably greater. This finding is in line with other research that found female T1DM patients had higher HDL values. Hormonal effects, especially estrogen, which has been demonstrated to have a positive impact on female lipid profiles during puberty, may be one of the mechanisms contributing to the gender-related variations in HDL levels.<sup>20,21</sup> Remarkably, male and female patients had similar BMI SDS and HbA1c levels, which may have an impact on HDL levels. Females may be somewhat protected against cardiovascular diseases by having higher HDL levels, and further research is necessary to determine the overall effects of gender-specific lipid variations. Our study assumed that the significantly greater HDL levels in pubertal girls with T1DM compared to boys were caused by the increased estrogen levels throughout puberty. Nevertheless, further extensive research is required to confirm the correctness of this finding. The greatest proportion of the cohort was at the pubertal stage, which is a crucial time for changes in metabolism and growth. Recent research has shown that puberty increases the risk of cardiovascular risk factors and lipid abnormalities, making careful monitoring and specialized management techniques vital during this time.<sup>18,22</sup>

The study confirmed the association between glycemic control and lipid metabolism by finding substantial relationships between HbA1c levels and lipid indicators. In particular, there was a negative correlation between greater HbA1c levels and HDL levels and a positive correlation with higher TC, LDL, and TG levels. These associations are corroborated by earlier research that revealed how poor glycemic control affects worsening lipid profiles and elevated cardiovascular risk in pediatric T1DM patients.<sup>12,23</sup> Researches have indicated a correlation between elevated HbA1c levels and a higher incidence of dyslipidemia in children with T1DM.<sup>12,24-26</sup> Despite notable progress, a subgroup of patients continue to have dyslipidemia, which is consistent with prior research that found a high incidence of dyslipidemia in pediatric T1DM populations.<sup>24,27</sup> These trials highlight the need for prompt treatments and routine lipid monitoring in managing dyslipidemia and averting long-term cardiovascular problems.

Our results on the frequency of cardiovascular risk factors are in line with earlier studies that highlight how important it is to identify and treat these risk factors early in order to reduce long-term health problems.<sup>28</sup> Other studies back this up by showing how important it is to evaluate lipid profiles early and regularly and to take preventive actions to lower cardiovascular risk in people with T1DM.<sup>23,29</sup> If there is a family history of hypercholesterolemia or early cardiovascular disease, or if the family history is unknown, screening is advised for children with T1DM beginning at age 2.<sup>13,14</sup> The noteworthy improvements in lipid profiles and glycemic control noted in our investigation underscore the efficacy of contemporary diabetes treatment approaches. Nonetheless, continuous attempts are required to tackle the high incidence of dyslipidemia and the potential risks that accompany it. In order to manage cardiovascular risk factors in pediatric T1DM patients, routine lipid screening, early intervention, and lifestyle modification education are essential.<sup>26,28</sup> Future studies should concentrate on understanding the fundamental processes causing these variations and creating targeted treatments that improve outcomes for all pediatric T1DM patients.

This study provides a thorough picture of patients' health conditions and changes over time through extensive data collecting at baseline and follow-up, including clinical, anthropometric, and laboratory parameters. The findings are more broadly applicable to the larger young T1DM group due to the nearly equal distribution of male and female patients and the inclusion of a wide age range. An understanding of the particular challenges and management requirements of this age group can be gained by concentrating on this critical developmental stage, especially during puberty. Designing effective treatments and monitoring strategies that address the particular physiological and psychological changes that T1DM patients go through during puberty requires an understanding of these dynamics.

It's possible that a one-year follow-up misses long-term consequences and issues related to T1DM, like the emergence of microvascular and macrovascular problems. Conducting the study in a single place may limit the findings' generalizability to different demographic and geographic groups. Due to potential differences between patients who attend follow-up appointments and those who do not, the study may contain inherent selection biases that could distort the data in favor of better outcomes. The prevalence of dyslipidemia and other cardiovascular risk factors in T1DM patients and their healthy counterparts cannot be directly compared due to the lack of a nondiabetic control cohort.

## Conclusions

This study shows that with the appropriate treatment, children with T1DM can significantly improve their metabolic results. Nonetheless, continuous attempts are required to tackle the high incidence of dyslipidemia and the potential risks that accompany it. To verify these findings and look into the underlying mechanisms causing these changes, more research with bigger sample sizes and longer follow-up periods is required. Pediatric T1DM management and long-term cardiovascular risk reduction continue to depend heavily on routine monitoring and customized treatments.

**Conflict of Interest**

The authors report no conflicts of interest.

**Funding**

This research was not supported by any specific grant from public, commercial, or non-profit funding agencies.

**Authorship Contribution**

This manuscript is based on the first author's residency thesis, supervised by the second author. Both authors contributed to the manuscript from the planning stages of the research through to its publication.

**References**

1. Svoren BM, Nicholas J. Diabetes Mellitus in Children. In: Kliegman RM, Stanton BF, St Geme JW, Schor NF, Behrman RE, eds. *Nelson Textbook of Pediatrics*. 20 ed. Elsevier Saunders; 2016:2760-83:chap 589.
2. Morales AE, She JX, Schatz DA. Genetics of type 1 diabetes. In: Pescovitz OH, Eugster EA (Eds). *Pediatric Endocrinology*. 1st ed. Philadelphia: Lippincott Williams & Wilkins; 2004:402-26.
3. Buse JB, Ginsberg HN, Bakris GL, et al. Primary prevention of cardiovascular diseases in people with diabetes mellitus: a scientific statement from the American Heart Association and the American Diabetes Association. *Diabetes Care*. Jan 2007;30(1):162-72. doi:10.2337/dc07-9917
4. McGill HC, Jr., McMahan CA, Malcom GT, Oalmann MC, Strong JP. Relation of glycohemoglobin and adiposity to atherosclerosis in youth. Pathobiological Determinants of Atherosclerosis in Youth (PDAY) Research Group. *Arterioscler Thromb Vasc Biol*. Apr 1995;15(4):431-40.
5. McGill HC, Jr., McMahan CA, Malcom GT, Oalmann MC, Strong JP. Effects of serum lipoproteins and smoking on atherosclerosis in young men and women. The PDAY Research Group. Pathobiological Determinants of Atherosclerosis in Youth. *Arterioscler Thromb Vasc Biol*. Jan 1997;17(1):95-106.
6. Hamad A, Qureshi JH. Dyslipidaemia in recently diagnosed young subjects of type 1 diabetes mellitus with normal/favourable BMI: a risk factor of macrovascular disease. *Biomedica*. 2008;24:130-133.
7. Neal WA, John CC. Disorders of lipoprotein metabolism and transport. In: Kliegman RM, Stanton BF, St Geme JW, Schor NF, Behrman RE (Eds.). *Nelson Textbook of Pediatrics*. 20th ed. Philadelphia: Elsevier Saunders; 2016:691-705.
8. Berenson GS, Srinivasan SR, Bao W, Newman WP, 3rd, Tracy RE, Wattigney WA. Association between multiple cardiovascular risk factors and atherosclerosis in children and young adults. The Bogalusa Heart Study. *N Engl J Med*. Jun 4 1998;338(23):1650-6. doi:10.1056/NEJM19980604 3382302
9. Maahs DM, Maniatis AK, Nadeau K, Wadwa RP, McFann K, Klingensmith GJ. Total cholesterol and high-density lipoprotein levels in pediatric subjects with type 1 diabetes mellitus. *J Pediatr*. Oct 2005;147(4):544-6. doi:10.1016/j.jpeds.2005.04.068
10. Vergès B. Lipid disorders in type 1 diabetes. In: Liu PC-P (Ed.). *Type 1 diabetes - Complications, Pathogenesis and Alternative Treatments*. Rijeka: InTech; 2011:45-60.
11. Edge JA, James T, Shine B. Longitudinal screening of serum lipids in children and adolescents with Type 1 diabetes in a UK clinic population. *Diabet Med*. Aug 2008;25(8):942-8. doi:10.1111/j.1464-5491.2008.02518.x
12. Dobrovolskiene R, Mockeviciene G, Urbonaite B, Jurgeviene N, Preiksa RT, Ostrauskas R. The risk of early cardiovascular disease in Lithuanian diabetic children and adolescents: a type 1 diabetes register database based study. *Diabetes Res Clin Pract*. Apr 2013;100(1):119-25. doi:10.1016/j.diabres.2013.01.022
13. Craig ME, Jefferies C, Dabelea D, et al. ISPAD Clinical Practice Consensus Guidelines 2014. Definition, epidemiology, and classification of diabetes in children and adolescents. *Pediatr Diabetes*. Sep 2014;15 Suppl 20:4-17. doi:10.1111/pedi.12186
14. American Diabetes A. Standards of medical care in diabetes 2016. *Diabetes Care*. Jan 2016;39 Suppl 1(1):1-102. doi:10.2337/dc16-S001
15. Donaghue KC, Wadwa RP, Dimeglio LA, et al. Microvascular and macrovascular complications in children and adolescents. *Pediatr Diabetes*. 2014;15 (Suppl. 20): 257-269. doi:10.1111/pedi.12180
16. Neyzi O, Günöz H, Furman A, et al. Türk çocuklarında vücut ağırlığı, boy uzunluğu, baş çevresi ve vücut kitle indeksi referans değerleri. *Çocuk Sağlığı Hast Derg*. 2008;51(1):1- 14.
17. Tümer N, Yalcinkaya F, Ince E, et al. Blood pressure nomograms for children and adolescents in Turkey. *Pediatr Nephrol*. Jun 1999;13(5):438-43. doi:10.1007/s004670050 636
18. Schwab KO, Doerfer J, Hecker W, et al. Spectrum and prevalence of atherogenic risk factors in 27,358 children, adolescents, and young adults with type 1 diabetes: cross-sectional data from the German diabetes documentation and quality management system (DPV). *Diabetes Care*. Feb 2006;29(2):218-25.
19. Redondo MJ, Foster NC, Libman IM, et al. Prevalence of cardiovascular risk factors in youth with type 1 diabetes and elevated body mass index. *Acta Diabetol*. Apr 2016;53(2):271-7. doi:10.1007/s00592-015-0785-1
20. Homma TK, Endo CM, Saruhashi T, et al. Dyslipidemia in young patients with type 1 diabetes mellitus. *Arch Endocrinol Metab*. Jun 2015;59(3):215-9. doi:10.1590/2359-3997000000040
21. Krantz JS, Mack WJ, Hodis HN, Liu CR, Liu CH, Kaufman FR. Early onset of subclinical atherosclerosis in young persons with type 1 diabetes. *J Pediatr*. Oct 2004;145(4):452-7. doi:10.1016/j.jpeds.2004.06.042
22. Silva L, Silva S, Oliveira AMS, et al. Hypertriglyceridemic Waist and Associated Factors in Children and Adolescents with Type 1 Diabetes Mellitus. *Rev Paul Pediatr*. 2020;38:e2019073. doi:10.1590/1984-0462/2020/38/20190 73
23. Maahs DM, Wadwa RP, McFann K, et al. Longitudinal lipid screening and use of lipid-lowering medications in pediatric type 1 diabetes. *J Pediatr*. Feb 2007;150(2):146-50, 150 e1-2. doi:10.1016/j.jpeds.2006.10.054
24. Bulut T, Demirel F, Metin A. The prevalence of dyslipidemia and associated factors in children and adolescents with type 1 diabetes. *J Pediatr Endocrinol Metab*. Feb 1 2017;30(2):181-187. doi:10.1515/jpem-2016-0111
25. Guy J, Ogden L, Wadwa RP, et al. Lipid and lipoprotein profiles in youth with and without type 1 diabetes: the SEARCH for Diabetes in Youth case-control study. *Diabetes Care*. Mar 2009;32(3):416-20. doi:10.2337/dc08-1775
26. Reh CM, Mittelman SD, Wee CP, Shah AC, Kaufman FR, Wood JR. A longitudinal assessment of lipids in youth with type 1 diabetes. *Pediatr Diabetes*. Jun 2011;12(4 Pt 2):365-71. doi:10.1111/j.1399-5448.2010.00733.x
27. Shah N, Khadilkar A, Gondhalekar K, Khadilkar V. Prevalence of dyslipidemia in Indian children with poorly controlled type 1 diabetes mellitus. *Pediatr Diabetes*. Sep 2020;21(6):987-994. doi:10.1111/pedi.13063
28. Bjornstad P, Donaghue KC, Maahs DM. Macrovascular disease and risk factors in youth with type 1 diabetes: time to be more attentive to treatment? *Lancet Diabetes Endocrinol*. Oct 2018;6(10):809-820. doi:10.1016/S2213-8587(18)30035-4
29. Noras K, Rusak E, Jarosz-Chobot P. The Problem of Abnormal Body Weight and Dyslipidemia as Risk Factors for Cardiovascular Diseases in Children and Adolescents with Type 1 Diabetes. *J Diabetes Res*. 2021;2021:5555149. doi:10.1155/2021/5555149



## Post-Earthquake PTSD: Identifying Key Risk Factors Eleven Months After the February 2023 Turkey Earthquakes

Yavuz Yılmaz<sup>1,a,\*</sup>, Erdi Bahadır<sup>2,b</sup>

<sup>1</sup> Department of Psychiatry, Faculty of Medicine, Sivas Cumhuriyet University, Sivas, Turkey

<sup>2</sup> Department of Psychiatry, Hackalı Baba State Hospital, Trabzon, Turkey

\*Corresponding author

### Research Article

#### History

Received: 25/02/2025

Accepted: 24/03/2025

#### Copyright



This work is licensed under  
Creative Commons Attribution 4.0  
International License

### ABSTRACT

#### Objective

Earthquakes are one of the most significant natural disasters, causing physical damage and psychological stress among victims. One of the major mental health issues that can arise after earthquakes is Posttraumatic Stress Disorder (PTSD). Our study aimed to investigate the prevalence of PTSD and PTSD risk factors in the eleventh month following the February 6, 2023 earthquakes in Turkey.

#### Methods

Our study was conducted between Dec 19, 2023, and Jan 2, 2024. All participants were given the Personal Information Form and, PTSD Checklist for DSM-5 (PCL-5). The Personal Information Form consists of three parts: survivors' characteristics, the characteristics of the trauma, and the post-trauma characteristics of the survivors.

#### Results

The study involved a total of 886 participants, aged between 18 and 65 years. Among the participants, 55.4% (n=491) were considered to have PTSD. The likelihood of receiving a diagnosis of PTSD is 2.95 times higher for male individuals, 2.07 times higher for injured individuals, 2.30 times higher for those who feel unable to escape their situation, and 2.03 times higher for individuals experiencing excessive fear or panic. Additionally, it is 1.65 times higher for individuals whose family member or close friend is injured, 1.82 times higher for individuals who lose their job after the earthquake, and 1.67 times higher for individuals experiencing economic problems after the earthquake.

#### Conclusion

Male gender, feeling trapped, experiencing extreme fear or panic, witnessing the injury of a family member or close friend, losing one's job after the earthquake, and facing economic problems after the earthquake are risk factors for PTSD.

**Keywords:** Earthquakes, posttraumatic stress disorder, risk factors

## Deprem Sonrası Travma Sonrası Stres Bozukluğu (TSSB): 6 Şubat 2023 Türkiye Depremlerinden On Bir Ay Sonra Temel Risk Faktörlerinin Belirlenmesi

### Araştırma Makalesi

#### Süreç

Gelis: 25/02/2025

Kabul: 24/03/2025

#### Telif Hakkı



Bu Çalışma Creative Commons Atf  
4.0 Uluslararası Lisansı  
Kapsamında Lisanslanmıştır.

### ÖZET

#### Amaç

Depremler, fiziksel hasara ve hayatta kalanlar arasında psikolojik strese neden olan en önemli doğal afetlerden biridir. Depremler sonrasında ortaya çıkabilecek en önemli ruh sağlığı sorunlarından biri Travma Sonrası Stres Bozukluğu'dur (TSSB). Bu çalışmada, 6 Şubat 2023 Türkiye depremlerinden on bir ay sonra TSSB yaygınlığı ve TSSB risk faktörlerinin incelenmesi amaçlanmıştır.

#### Yöntem

Çalışma, 19 Aralık 2023 ile 2 Ocak 2024 tarihleri arasında gerçekleştirilmiştir. Tüm katılımcılara Kişisel Bilgi Formu ve DSM-5 Travma Sonrası Stres Bozukluğu Kontrol Listesi (PCL-5) uygulanmıştır. Kişisel Bilgi Formu üç bölüme ayrılmıştır: hayatta kalanların demografik özellikleri, travmanın özellikleri ve travma sonrası dönem özellikleri.

#### Bulgular

Çalışmaya 18-65 yaş aralığında toplam 886 katılımcı dahil edilmiştir. Katılımcıların %55,4'ü (n=491) TSSB tanı kriterlerini karşılamaktadır. TSSB tanısı alma olasılığı erkek bireylerde 2,95 kat, yaralanan bireylerde 2,07 kat, kaçamayacağını hisseden bireylerde 2,30 kat ve aşırı korku veya panik yaşayan bireylerde 2,03 kat daha yüksek bulunmuştur. Ayrıca, aile üyesi veya yakın bir arkadaşı yaralanan bireylerde bu olasılık 1,65 kat, deprem sonrası işini kaybeden bireylerde 1,82 kat ve ekonomik sorunlar yaşayan bireylerde 1,67 kat daha fazladır.

#### Sonuç

Erkek cinsiyet, kaçışın imkansız olduğu algısı, aşırı korku veya panik yaşama, bir aile üyesi ya da yakın arkadaşın yaralanmasına tanıklık etme, deprem sonrası iş kaybı ve ekonomik sorunlarla karşı karşıya kalma, TSSB için önemli risk faktörleri olarak belirlenmiştir.

**Anahtar Kelimeler:** Deprem, travma sonrası stres bozukluğu, risk faktörleri

<sup>a</sup> dr.yavuzz@hotmail.com

<sup>b</sup> 0000-0002-7572-5474

erdibhdr@gmail.com

0000-0002-8404-1779

## Introduction

In the last few decades, earthquakes, which frequently occur and cause significant destruction, have been one of the major natural disasters that cause physical damage and psychological stress among the victims.<sup>1,2</sup> On Feb 6, 2023, Turkey was shaken by the largest earthquake disaster in the country's history. The earthquakes occurred in the province of Kahramanmaraş, located in the south of the country, and affected more than ten cities. The first earthquake occurred at 04:17 local time with a magnitude of 7.7 recorded instrumentally. The second earthquake occurred on the same day at 13:24 local time, with a magnitude of 7.6.<sup>3</sup> These earthquakes affected 14 million people, constituting 16% of Turkey's population. More than 35,000 buildings were ruined, over 50,000 people lost their lives, and more than 100,000 people were injured.<sup>4</sup> Following a catastrophic natural disaster of this magnitude, which impacted millions of individuals, a substantial proportion of the affected population is at heightened risk of developing severe mental health conditions. Among these, PTSD emerges as a critical psychological consequence that warrants thorough investigation.

PTSD is any traumatic event followed by specific symptoms such as re-experiencing, hyperarousal, avoidance, and alienation lasting more than a month, causing impairment in social and occupational functioning.<sup>5</sup> There are significant differences reported in PTSD rates following earthquakes.<sup>6,7</sup> A meta-analysis indicated that the prevalence of PTSD after earthquakes in adults ranged from 4.10% to 67.07%.<sup>8</sup> Similarly, the study noted variations in predictors of PTSD following earthquakes. While some studies suggest that older age is a risk factor for developing PTSD after earthquakes, others have found contradictory results. The same applies to being injured during the earthquake and marital status (8). The variability in PTSD rates and predictors has been associated with several factors, including the severity of the earthquake, the degree of trauma experienced by the victims, the timing of PTSD assessment, the amount of property loss, and the mourning process.<sup>9,10</sup>

The absence of a single dominant predictor for post-earthquake PTSD emphasizes the importance of examining risk factors. These risk factors can be classified into the survivors' characteristics, the trauma's characteristics, and the survivors' post-trauma characteristics. The basic characteristics of survivors include age, gender, education level, income level, and trauma history. Accordingly, older age, female gender, and a history of traumatic events increase the risk of developing PTSD.<sup>8,11</sup> Studies on education levels yield conflicting results, with some indicating that a lower education level is a risk factor while others suggest that a higher education level poses a risk.<sup>8,11</sup> Regarding the characteristics of the trauma, factors such as injury, facing death, witnessing death or injury, being buried or trapped during a natural disaster, experiencing fear and anxiety during the earthquake, and feelings of guilt are all risk factors for PTSD.<sup>8,11</sup> In terms of post-trauma characteristics of survivors, factors such as damage or collapse of the home, loss of employment, lack of social support, participation in

rescue efforts, and experiencing traumatic events during the post-earthquake period are risk factors for PTSD.<sup>8,11</sup>

In this study, we examine the factors that increase the risk of developing PTSD among individuals affected by the 2023 Turkey earthquakes. It is hypothesized that the prevalence of PTSD will be significantly higher in individuals who experienced severe trauma during the earthquake, such as injury, loss of loved ones, or being trapped under rubble. Additionally, it is predicted that women, older individuals, and those with lower education or income levels will be at greater risk of developing PTSD. Furthermore, factors such as the extent of property loss, lack of social support, and participation in post-earthquake rescue efforts are expected to increase the likelihood of PTSD. The study also anticipates that the combination of multiple risk factors will further elevate the probability of developing PTSD.

## Materials and Methods

### *Procedure and participants*

Our study was conducted between Dec 19, 2023, and Jan 2, 2024. All participants were given the Personal Information Form and PCL-5. Surveys were created using Google Documents. An introductory note explaining the purpose of the study in detail and an assurance that the data would be kept confidential was sent to the individuals. A consent tab stating that participation in the survey was based on voluntariness was added, and online consent was received from those who accepted to participate voluntarily. After obtaining informed consent, those who agreed to participate in the study could continue filling out the scales. This survey was sent to all participants using WhatsApp Messenger, a free American software owned by Facebook Inc., a cross-platform messaging service. All stages of this study were carried out in accordance with the rules of the Helsinki Declaration. Inclusion criteria for the research were being literate, volunteering to participate in the study, having personally experienced the earthquake, and being over 18 years old. Exclusion criteria for the research were diagnosis of schizophrenia, bipolar affective disorder, intellectual disability, and autism spectrum disorder.

### *Measures*

#### *Personal Information Form*

It is a standardized questionnaire created by the researchers, in which survivors' characteristics (such as age, gender, marital status, income level), the trauma's characteristics (such as injury, witnessing someone else's death or injury, being buried during a natural disaster, experiencing a feeling of being trapped) and the survivors' post-trauma characteristics (such as damage or destruction of the house, loss of employment, experiencing economic problems) are questioned.

#### *Posttraumatic Stress Disorder Checklist for DSM-5*

It was developed by Weathers et al.<sup>12</sup> to measure PTSD symptoms. It consists of 20 items. It contains four factors. These factors are re-experiencing, avoidance, negative changes in cognition and mood, and hyperarousal. The Turkish adaptation of the scale was carried out by Boysan et al.<sup>13</sup> The internal consistency coefficient of the scale was

found to be in the range of .64-.78. Boysan et al. suggested a cut-off score  $\geq 47$  for PTSD diagnosis with PCL-5.

**Statistical Analysis**

SPSS 26.0 package programs were used in the analysis of the data. Frequency analysis was used for person and percentage distribution, Chi-Square analysis was used to examine the differences in diagnostic status according to cities, and Logistic Regression analysis was used to examine the predictive relationships between variables. Statistical significance was accepted as  $p < 0.05$ .

**Results**

The study involved a total of 886 participants, with 611 (69%) females aged between 18 and 65 years (mean age =

$27.72 \pm 8.61$ ) and 275 (31%) males aged between 18 and 70 years (mean age =  $34.04 \pm 12.40$ ). Among the participants, 55.4% (n=491) were considered to have PTSD. Of the participants, 56% (n=496) were married, and 80.5% (n=713) had a college or university degree. About 24.3% (n=215) of the participants reported having experienced a similar event in the past, while 10.2% (n=90) indicated a history of psychiatric treatment. The percentage of participants injured in the earthquake was 7.8% (n=69), and 42.3% (n=375) witnessed someone's death. About 47.5% (n=421) of the participants reported minor damage to their homes, while 51.6% (n=457) had lost a family member or close friend. The characteristics of the participants, the characteristics of the trauma, and the post-trauma characteristics of the survivors are summarized in Table 1.

**Table 1.** Sociodemographic characteristics of the survivors. the characteristics of the trauma. and the post-trauma characteristics of the survivors

Variable	Category	n	%
Gender	Female	611	69.0
	Male	275	31.0
	<b>Total</b>	<b>886</b>	<b>100.0</b>
Marital status	Single	348	39.3
	Married	496	56.0
	Divorced or Widow	42	4.7
	<b>Total</b>	<b>886</b>	<b>100.0</b>
Educational level	Primary school	15	1.7
	High School	158	17.8
	College/University	713	80.5
	<b>Total</b>	<b>886</b>	<b>100.0</b>
Employment	Student	243	27.4
	Not working	192	21.7
	Works at own workplace	37	4.2
	Public employee	237	26.7
	Private sector employee	177	20.0
	<b>Total</b>	<b>886</b>	<b>100.0</b>
Income*	Minimum wage and below	489	55.2
	Up to twice the minimum wage	223	25.2
	More than twice the minimum wage	174	19.6
	<b>Total</b>	<b>886</b>	<b>100.0</b>
Did you undergo any psychiatric treatment in the period before the earthquake?	Yes	90	10.2
	No	796	89.8
	<b>Total</b>	<b>886</b>	<b>100.0</b>
Have you experienced a traumatic event like this before?	Yes	215	24.3
	No	671	75.7
	<b>Total</b>	<b>886</b>	<b>100.0</b>
Did you get injured?	Yes	69	7.8
	No	817	92.2
	<b>Total</b>	<b>886</b>	<b>100.0</b>
Did you get trapped or stuck under the rubble?	Yes	30	3.4
	No	856	96.6
	<b>Total</b>	<b>886</b>	<b>100.0</b>
Did you feel like you cannot escape the situation you are in?	Yes	761	85.9
	No	125	14.1
	<b>Total</b>	<b>886</b>	<b>100.0</b>
Did you experience extreme fear or panic?	Yes	772	87.1
	No	114	12.9
	<b>Total</b>	<b>886</b>	<b>100.0</b>
	Yes	730	82.4

Did you ever feel that your life or the life of a family member was in danger?	No	156	17.6
	<b>Total</b>	<b>886</b>	<b>100.0</b>
Did you directly witness someone else being injured?	Yes	375	42.3
	No	511	57.7
	<b>Total</b>	<b>886</b>	<b>100.0</b>
Did you witness someone else's death directly?	Yes	279	31.5
	No	607	68.5
	<b>Total</b>	<b>886</b>	<b>100.0</b>
Did you witness someone else being trapped or stuck under rubble?	Yes	287	32.4
	No	599	67.6
	<b>Total</b>	<b>886</b>	<b>100.0</b>
House damage	Undamaged	252	28.4
	Slightly damaged	421	47.5
	Heavily damaged	178	20.1
	Ruined	35	4.0
	<b>Total</b>	<b>886</b>	<b>100.0</b>
Did you lose your job after the earthquake?	Yes	107	12.1
	No	779	87.9
	<b>Total</b>	<b>886</b>	<b>100.0</b>
Did you have economic problems after the earthquake?	Yes	568	64.1
	No	318	35.9
	<b>Total</b>	<b>886</b>	<b>100.0</b>
Did a family member or close friend get injured?	Yes	460	51.9
	No	426	48.1
	<b>Total</b>	<b>886</b>	<b>100.0</b>
Did a family member or close friend die?	Yes	457	51.6
	No	429	48.4
	<b>Total</b>	<b>886</b>	<b>100.0</b>
Did you need surgery?	Yes	6	0.7
	No	880	99.3
	<b>Total</b>	<b>886</b>	<b>100.0</b>
Which city were you in at the time of the earthquake?	Kahramanmaraş	183	20.7
	Hatay	128	14.4
	Malatya	191	21.6
	Adiyaman	60	6.8
	Gaziantep	29	3.3
	Diyarbakır	53	6.0
	Osmaniye	12	1.4
	Adana	39	4.4
	Kilis	1	.1
	Şanlıurfa	30	3.4
	Other cities	160	18.1
	<b>Total</b>	<b>886</b>	<b>100.0</b>
Diagnosis of PTSD	Yes	491	55.4
	No	395	44.6
	<b>Total</b>	<b>886</b>	<b>100.0</b>

\* The level of income was determined by the minimum wage value on the date of the study.  
PTSD: Posttraumatic Disorder

In the conducted regression analysis, those without a diagnosis of PTSD were coded as 0, while those with a diagnosis of PTSD were coded as 1, and stepwise logistic regression analysis was performed. According to the results of the Hosmer and Lemeshow Test, it was observed that the model fit was good ( $X^2_{(8)}=8,116$ ;  $p>0,05$ ). In the block model, the prediction percentage was 55.4%, while in the model, including independent variables, the prediction rate was calculated as 68.3%. As a result of the analysis, gender (Wald=42.314;  $p<0.001$ ), loss of employment (Wald=5.616;  $p<0.05$ ), economic problems (Wald=10.207;  $p<0.05$ ), injury

status (Wald=5.128;  $p<0.05$ ), injury to a family member or close friend (Wald=10.476;  $p<0.01$ ), feeling unable to escape (Wald=11.715;  $p<0.01$ ), and feelings of fear/panic (Wald=7.810;  $p<0.01$ ) were found to be significant parameters. These variables explain 21% of the occurrence of PTSD diagnosis. Holding other variables constant, the likelihood of receiving a diagnosis of PTSD is 2.95 times higher for male individuals, 2.07 times higher for injured individuals, 2.30 times higher for those who feel unable to escape their situation, and 2.03 times higher for individuals experiencing excessive fear or panic. Additionally, it is 1.65 times higher for



individuals whose family member or close friend is injured, 1.82 times higher for individuals who lose their job after the earthquake, and 1.67 times higher for individuals experiencing economic problems after the earthquake.

Logistic regression analysis findings for PTSD diagnosis are summarized in Table 2.

**Table 2.** Logistic Regression Analysis Results for Diagnosis of Posttraumatic Stress Disorder.

Variables	B	SH	Wald	p	Exp(B)	Confidence Interval	
						Low	High
Constant (a)	-2.563	0.295	75.355	0.000	0.077		
Gender	1.083	0.166	42.314	0.000	2.953	2.131	4.093
Did you get injured?	0.727	0.321	5.128	0.024	2.070	1.103	3.885
Did you feel like you cannot escape the situation you are in?	0.833	0.243	11.715	0.001	2.300	1.427	3.705
Did you experience extreme fear or panic?	0.707	0.253	7.810	0.005	2.028	1.235	3.330
Did you lose your job after the earthquake?	0.596	0.252	5.616	0.018	1.815	1.109	2.972
Did you have economic problems after the earthquake?	0.514	0.161	10.207	0.001	1.672	1.220	2.292
Did a family member or close friend get injured?	0.498	0.154	10.476	0.001	1.646	1.217	2.226

**Table 3.** Examination of the Difference Between the Distribution of Place of Residence According to Diagnosis of Posttraumatic Stress Disorder.

		Diagnosis of PTSD		X <sup>2</sup> (4)	p	
		No	Yes			
City	Kahramanmaraş	n	90	93	11.678	0.020
		Line percentage	49.2%	50.8%		
	Hatay	n	42	86		
		Line percentage	32.8%	67.2%		
	Malatya	n	79	112		
		Line percentage	41.4%	58.6%		
	Adiyaman	n	31	29		
		Line percentage	51.7%	48.3%		
	Other Cities	n	153	171		
		Line percentage	47.2%	52.8%		

PTSD: Posttraumatic Disorder

It was observed that the distributions of participants diagnosed with PTSD and those without PTSD were statistically significant based on their places of residence (X<sup>2</sup>(4)=11,678; p<0,05). When examining the table overall, it is seen that 67.2% of the participants residing in Hatay have a diagnosis of posttraumatic stress disorder. Following Hatay, this rate is followed by Malatya, other cities, Kahramanmaraş, and Adiyaman, respectively (Table 3).

**Discussion**

The study was conducted in the eleventh month following the February 6th Turkey earthquake. The rate of

participants diagnosed with PTSD was 55.4% (n=491). The likelihood of receiving a diagnosis of PTSD was significantly higher in males, injured individuals, individuals whose family member or close friend was injured, those who felt unable to escape their situation, and those experiencing excessive fear or panic. Furthermore, it was higher among individuals who lost their jobs after the earthquake and those experiencing economic problems following it.

The lifetime prevalence of PTSD can vary between 0.5% and 14.5%, and this variability may differ across different regions of the world depending on factors such as the type of trauma, the intensity of exposure, and the level of posttraumatic social support.<sup>14</sup> Studies provide

different results regarding the prevalence of PTSD in the post-earthquake period. A meta-analysis reported that the prevalence of PTSD after earthquakes ranged from 4.10% to 67.07% in adults and from 2.50% to 60.00% in children.<sup>8</sup> In a meta-analysis examining the prevalence of PTSD after earthquakes in Iran and Pakistan, the overall prevalence of PTSD was found to be 55.6%. This rate was 60.2% among Iranian participants and 49.2% among Pakistani participants.<sup>15</sup> The same study also indicated a decrease in the prevalence of PTSD over time. However, another meta-analysis showed a global prevalence of PTSD after earthquakes to be 23.66%, which is considerably lower than the rate found in our study.<sup>16</sup> Significant differences in the prevalence rates of PTSD have been attributed to individual vulnerability factors such as age and gender, exposure factors such as damage or collapse of the home, and factors related to the posttraumatic period such as the death of family members or friends.<sup>17</sup> Furthermore, the timing and method of assessment of PTSD can also lead to differences in prevalence rates. Symptoms of the disorder may diminish or disappear over time, so the time elapsed between the occurrence of the earthquake and the assessment may affect the prevalence of PTSD. A systematic review found that the prevalence of PTSD decreased from 28.8% at one month to 17.0% at 12 months post-earthquake.<sup>18</sup> Additionally, different methods used for assessing PTSD, such as questionnaires or clinical interviews, can yield different results. It has been observed that the deviation in results obtained from clinical interviews is lower compared to self-report scales. This finding suggests clinical interviews may provide more accurate diagnoses than self-report scales. However, it is important to note that both methods can yield either higher or lower results when compared to each other, as seen in the literature.<sup>19</sup>

Gender is considered an individual vulnerability factor for the development of PTSD. Female gender is identified as a significant predictor of PTSD development in adults. Study results consistently show that the prevalence of PTSD among women is higher than among men.<sup>8,11,15,16</sup> Sociocultural and cognitive factors play an important role in explaining gender differences. Especially in developing countries, sociocultural factors that affect a woman's vulnerability are of great importance. In such societies, limited access for women to decision-making processes and prominent values and traditions can make women more vulnerable to the effects of disasters.<sup>20,21</sup> In our study, contrary to the literature, we found that the risk of developing PTSD in men was 2.95 times higher. We believe that one possible reason for this could be the predominant involvement of men in rescue efforts during the post-earthquake period, leading to increased exposure to traumatic stimuli among men. The fact that the frequency of PTSD is shown to increase among those involved in search and rescue operations during the post-trauma period also supports our findings.<sup>22</sup> Beyond the direct exposure to trauma during rescue efforts, other factors may also explain the higher PTSD rates among men in our study. For instance, traditional gender roles in many

societies often discourage men from seeking emotional support or expressing vulnerability, which may hinder their ability to cope effectively with traumatic experiences. Additionally, men may face societal pressures to remain resilient in the face of disaster, potentially leading to the internalization of stress and trauma. These factors, combined with their active role in post-disaster recovery, could collectively contribute to the elevated PTSD risk observed among men in our sample. While our findings challenge the general consensus in the literature, they underscore the importance of considering contextual and cultural factors when examining PTSD risk. Future studies should further explore the interplay between gender roles, societal expectations, and trauma exposure in shaping PTSD outcomes, particularly in disaster-affected populations.

It is known that trauma-related characteristics such as being injured, confronting death, witnessing death or injury, being buried during a natural disaster, feeling trapped, experiencing fear during the earthquake, anxiety levels and feelings of guilt are risk factors for PTSD.<sup>8,11</sup> In our study, factors such as being injured, feeling unable to escape from the situation, and experiencing excessive fear or panic, as well as having a family member or close friend injured, were found to increase the risk of developing PTSD. A study conducted 17 years after the Bam earthquake in Iran found that a significant portion of participants still exhibited symptoms of PTSD, and physical injury, being trapped under debris, and the death of a family member were identified as risk factors for PTSD.<sup>23</sup> The connection between injury and PTSD is likely related to the severity of injuries; severe injuries can lead to amputation and disability after the earthquake.<sup>24</sup> Disability results in a significant decrease in the quality of life for these individuals and can lead to PTSD. Additionally, injured individuals are always at high risk stemming from experiencing a life-threatening trauma. The rehabilitation process after injury can also be a constant reminder and an additional source of stress.<sup>25</sup> Similarly, Abolhadi et al. found significant positive associations between injury and the development of PTSD, particularly emphasizing that this relationship is more pronounced in individuals showing moderate to high levels of PTSD symptoms.<sup>23</sup> Consistently, the relationship between injury and the development of PTSD has been demonstrated in numerous studies.<sup>26-30</sup> Considering that PTSD is a fear-based disorder, the fear experienced during the earthquake can be a strong determinant of PTSD. There are studies supporting this notion, showing a relationship between the initial level of fear experienced during the earthquake and PTSD.<sup>31,32</sup> Similarly, the feeling of being unable to escape and fear have been associated with the development of PTSD.<sup>33,34</sup> Consistent with our study findings, having a close family member or friend injured has also been identified as a risk factor for the development of PTSD.<sup>34-37</sup>

Regarding post-trauma characteristics, factors such as the destruction or damage of a home, loss of employment, and low social support are associated with

the development of PTSD.<sup>8-11</sup> In our study, an increased risk of developing PTSD was found among those who lost their jobs and experienced economic problems after the earthquake. Unemployment caused by the earthquake may reflect the severity of the trauma to some extent. Additionally, unemployment may prevent individuals from providing for their families as they did before the disaster. It is crucial to support employment and income-generating activities as soon as possible. Low social support is known to be a risk factor for the development of PTSD.<sup>31,32</sup> In this regard, social and financial support from family, friends, or official authorities can mitigate the negative effects of trauma. Measures taken by governments and aid organizations in this regard are crucial.

Earthquakes are natural disasters that can affect wide geographical areas. Therefore, as the distance from the earthquake's epicentre increases, the earthquake's impact decreases. In our study, we investigated whether there was a difference between being at the earthquake's epicentre and being in a different city by asking participants where they were during the earthquake. We examined whether there was a difference in the development of PTSD among participants who were in the epicentre of the earthquake (Kahramanmaraş) and those in other heavily affected cities (Hatay, Malatya, and Adiyaman), as well as participants from other cities affected by the earthquake. We found that the distribution of participants with and without PTSD varied significantly depending on where they lived. Specifically, participants living in Hatay had the highest percentage of PTSD development (67.2%), followed by Malatya, other cities, Kahramanmaraş, and Adiyaman, respectively. Proximity to the disaster area can significantly affect the impact of the disaster, but it is not sufficient to consider it alone. In addition, factors such as the severity of the disaster, personality traits, and effectiveness of social support systems should be considered. One possible reason for the high rate of PTSD among participants in Hatay, where the earthquake occurred, maybe the occurrence of another earthquake with a magnitude of 6.4 on Feb 20, 2023, which was also centered in Hatay. This earthquake may have increased the destruction in Hatay and caused individuals affected to be re-traumatized. Given the extensive area affected by the earthquake and the limited search and rescue capabilities, there may have been difficulties in assisting in such a wide area, with a particular focus on Kahramanmaraş due to being the earthquake's epicentre. This situation may explain why the percentage of PTSD development in Malatya and other cities is higher than in Kahramanmaraş despite being the epicentre of the earthquake.

In our study, unlike previous research, we found that variables such as age, marital status, education level, income level, extent of home damage, being trapped under debris, witnessing someone else's death or injury, and the death of a family member or close friend were not risk factors for the development of PTSD. This finding may be attributed to various factors such as sample selection

and sample size, the majority being college or university graduates, and most of the sample having minimal damage to their homes.

Our study has several important limitations that should be acknowledged. Firstly, the cross-sectional design of the study may limit the accuracy of the findings compared to longitudinal studies, which can provide more reliable insights into the development and progression of PTSD over time. Secondly, the reliance on self-report scales for data collection may lead to discrepancies between the reported prevalence of PTSD and the actual prevalence, as self-reports can be influenced by response biases or subjective interpretations. More precise results could be obtained through face-to-face clinical interviews conducted by trained professionals. Thirdly, the majority of the sample consisted of individuals with a high level of education, which may limit the generalizability of the findings to populations with lower educational attainment or different socioeconomic backgrounds. Additionally, the recruitment of participants exclusively through WhatsApp may have excluded individuals who do not use this platform, further restricting the representativeness of the sample. This approach likely overlooked certain demographic groups, such as older adults or those with limited access to technology, who may have different experiences and vulnerabilities related to PTSD. Despite these limitations, the study has notable strengths, including a relatively large sample size, the inclusion of participants from multiple cities, and the analysis of data from cities both near and far from the earthquake's epicentre. This allowed us to explore the relationship between proximity to the epicentre, the severity of damage, and the development of PTSD, providing valuable insights into the broader impact of the disaster.

## Conclusion and Recommendations

In conclusion, male gender, feeling trapped, experiencing extreme fear or panic, witnessing the injury of a family member or close friend, losing one's job after the earthquake, and facing economic problems after the earthquake are risk factors for PTSD.

To enhance post-disaster mental health support, several practical measures can be implemented. First, early screening programs should be established to identify individuals at high risk of PTSD immediately after the disaster, enabling timely access to evidence-based interventions such as trauma-focused cognitive behavioral therapy (CBT). Second, community-based mental health initiatives, including support groups and psychoeducation workshops, should be developed to provide accessible and culturally sensitive care. Third, first responders and volunteers should receive trauma-informed training to recognize signs of PTSD and offer psychological first aid, which can also help mitigate their own risk of trauma-related mental health issues. Additionally, economic and social support programs, such as financial assistance, job placement services, and housing support, should be prioritized to alleviate post-

disaster stressors and improve mental health outcomes. Long-term mental health monitoring systems should also be implemented to track survivors' well-being and identify delayed-onset PTSD, ensuring continuous support. Finally, public awareness campaigns can help normalize

discussions about mental health, reduce stigma, and encourage help-seeking behavior among affected populations. These strategies, when integrated into disaster response plans, can significantly improve mental health outcomes for earthquake survivors.

## References

- Aker AT. 1999 Marmara Depremleri: Epidemiyolojik Bulgular ve Toplum Ruh Sağlığı Uygulamaları Üzerine Bir Gözden Geçirme [1999 Marmara earthquakes: a review of epidemiologic findings and community mental health policies]. *Türk Psikiyatri Derg.* 2006;17(3):204-212.
- Ali M, Farooq N, Bhatti MA, Kuroiwa C. Assessment of prevalence and determinants of posttraumatic stress disorder in survivors of earthquake in Pakistan using Davidson Trauma Scale. *J Affect Disord.* 2012;136(3):238-243. doi:10.1016/j.jad.2011.12.023
- 06 Şubat 2023 Kahramanmaraş (Pazarcık Ve Elbistan) Depremleri Saha Çalışmaları Ön Değerlendirme Raporu. Available from [https://depem.afad.gov.tr/assets/pdf/Arazi\\_Onrapor\\_28022023\\_surum1\\_revize.pdf](https://depem.afad.gov.tr/assets/pdf/Arazi_Onrapor_28022023_surum1_revize.pdf)
- [https://tr.wikipedia.org/wiki/2023\\_Kahramanmara%C5%9F\\_depremleri](https://tr.wikipedia.org/wiki/2023_Kahramanmara%C5%9F_depremleri)
- American Psychiatric Association. (2013). Diagnostic and Statistical Manual of Mental Disorders (5th ed.). <https://doi.org/10.1176/appi.books.9780890425596>
- Zhang Y, Ho SM. Risk factors of posttraumatic stress disorder among survivors after the 512 Wenchuan earthquake in China. *PLoS One.* 2011;6(7):e22371. doi:10.1371/journal.pone.0022371
- Zhang Z, Ran MS, Li YH, et al. Prevalence of post-traumatic stress disorder among adolescents after the Wenchuan earthquake in China. *Psychol Med.* 2012;42(8):1687-1693. doi:10.1017/S0033291711002844
- Tang B, Deng Q, Glik D, Dong J, Zhang L. A Meta-Analysis of Risk Factors for Post-Traumatic Stress Disorder (PTSD) in Adults and Children after Earthquakes. *Int J Environ Res Public Health.* 2017;14(12):1537. Published 2017 Dec 8. doi:10.3390/ijerph14121537
- Dell'Osso L, Carmassi C, Massimetti G, et al. Age, gender and epicenter proximity effects on post-traumatic stress symptoms in L'Aquila 2009 earthquake survivors. *J Affect Disord.* 2013;146(2):174-180. doi:10.1016/j.jad.2012.08.048
- Teramoto C., Matsunaga A., Nagata S. Cross-sectional study of social support and psychological distress among displaced earthquake survivors in Japan. *Jpn. J. Nurs. Sci.* 2015;12:320-329. doi: 10.1111/jjns.12071.
- Liang Y, Cheng J, Ruzek JI, Liu Z. Posttraumatic stress disorder following the 2008 Wenchuan earthquake: A 10-year systematic review among highly exposed populations in China. *J Affect Disord.* 2019;243:327-339. doi:10.1016/j.jad.2018.09.047
- Weathers, F. W., Litz, B. T., Keane, T. M., Palmieri, P. A., Marx, B. P., & Schnurr, P. P. The PTSD checklist for DSM-5 (PCL-5). Scale available from the National Center for PTSD at [www.ptsd.va.gov](http://www.ptsd.va.gov), 2013;10(4).206.
- Boysan, M., Guzel Ozdemir, P., Ozdemir, O., Selvi, Y., Yılmaz, E., & Kaya, N. Psychometric properties of the Turkish version of the PTSD Checklist for Diagnostic and Statistical Manual of Mental Disorders, (PCL-5). *Psychiatry and Clinical Psychopharmacology*, 2017;27(3):300-310.
- Uniyal A, Singh R, Akhtar A, Dhaliwal J, Kuhad A, Sah SP. Pharmacological rewriting of fear memories: A beacon for post-traumatic stress disorder. *Eur J Pharmacol.* 2020;870:172824. doi:10.1016/j.ejphar.2019.172824
- Hosseinejad M, Yazdi-Feyzabadi V, Hajebi A, et al. Prevalence of Posttraumatic Stress Disorder Following the Earthquake in Iran and Pakistan: A Systematic Review and Meta-Analysis [published correction appears in *Disaster Med Public Health Prep.* 2022 Apr;16(2):841]. *Disaster Med Public Health Prep.* 2022;16(2):801-808. doi:10.1017/dmp.2020.411
- Dai W, Chen L, Lai Z, Li Y, Wang J, Liu A. The incidence of post-traumatic stress disorder among survivors after earthquakes: a systematic review and meta-analysis. *BMC Psychiatry.* 2016;16:188. Published 2016 Jun 7. doi:10.1186/s12888-016-0891-9
- Naeem F, Ayub M, Masood K, et al. Prevalence and psychosocial risk factors of PTSD: 18 months after Kashmir earthquake in Pakistan. *J Affect Disord.* 2011;130(1-2):268-274. doi:10.1016/j.jad.2010.10.035
- Santiago PN, Ursano RJ, Gray CL, et al. A systematic review of PTSD prevalence and trajectories in DSM-5 defined trauma exposed populations: intentional and non-intentional traumatic events. *PLoS One.* 2013;8(4):e59236. Published 2013 Apr 11. doi:10.1371/journal.pone.0059236
- Paykel E, Norton K. Self-report and clinical interview in the assessment of depression. In: Sartorius N, Ban TA, eds. *Assessment of Depression.* Springer Berlin Heidelberg; 1986:356-366
- Wade D, Fletcher S, Carty J, Creamer M. Post-traumatic stress disorder in women. In: Castle DJ, Abel KM, eds. *Comprehensive Women's Mental Health.* UK: Cambridge University Press; 2016:208.
- Baig MN, Sharif R, eds. Gender perspective considerations in disasters like earthquakes and floods of Pakistan. *Proceedings of World Academy of Science, Engineering and Technology.* New York: World Academy of Science, Engineering and Technology (WASET); 2013.
- Tang B, Liu X, Liu Y, Xue C, Zhang L. A meta-analysis of risk factors for depression in adults and children after natural disasters. *BMC Public Health.* 2014;14:623. Published 2014 Jun 19. doi:10.1186/1471-2458-14-623
- Abolhadi E, Divsalar P, Mosleh-Shirazi MA, Dehesh T. Latent classes of posttraumatic stress disorder among survivors of the Bam Earthquake after 17 years. *BMC Psychiatry.* 2022;22(1):603. Published 2022 Sep 10. doi:10.1186/s12888-022-04216-3
- Ekşi A, Braun KL, Ertem-Vehid H, et al. Risk factors for the development of PTSD and depression among child and adolescent victims following a 7.4 magnitude earthquake. *Int J Psychiatry Clin Pract.* 2007;11(3):190-199. doi:10.1080/13651500601017548
- Chen G, Shen H, Chen G. A cross-sectional study on posttraumatic stress disorder among elderly Qiang citizens 3 years after the Wenchuan earthquake in China. *Can J Psychiatry.* 2012;57(9):547-553. doi:10.1177/070674371205700905
- Jin Y, Li J. Prospective Study of Posttraumatic Stress in Adolescents 6 and 24 Months After the 2010 Yushu Earthquake in China. *J Nerv Ment Dis.* 2015;203(9):679-683. doi:10.1097/NMD.0000000000000351

27. Ma X, Liu X, Hu X, et al. Risk indicators for post-traumatic stress disorder in adolescents exposed to the 5.12 Wenchuan earthquake in China. *Psychiatry Res.* 2011;189(3):385-391. doi:10.1016/j.psychres.2010.12.016
28. Liu Q, Jiang M, Yang Y, et al. Prevalence of Posttraumatic Stress Disorder (PTSD) and Its Correlates Among Junior High School Students at 53 Months After Experiencing an Earthquake. *Disaster Med Public Health Prep.* 2019;13(3):414-418. doi:10.1017/dmp.2018.76
29. Wen J, Shi YK, Li YP, Yuan P, Wang F. Quality of life, physical diseases, and psychological impairment among survivors 3 years after Wenchuan earthquake: a population based survey. *PLoS One.* 2012;7(8):e43081. doi:10.1371/journal.pone.0043081
30. Zhou X, Kang L, Sun X, et al. Prevalence and risk factors of post-traumatic stress disorder among adult survivors six months after the Wenchuan earthquake. *Compr Psychiatry.* 2013;54(5):493-499. doi:10.1016/j.comppsy.2012.12.010
31. Xu J, Song X. Posttraumatic stress disorder among survivors of the Wenchuan earthquake 1 year after: prevalence and risk factors. *Compr Psychiatry.* 2011;52(4):431-437. doi:10.1016/j.comppsy.2010.08.002
32. Zhao, G.F., Yang, Y.C., Zhang, Q., Zhang, S.S., Deng, H., Zhu, Y., et al. Prevalence and related factors for PTSD in community residents after the Wenchuan earthquake. *Chin. Ment. Health J.* 2009;23, 478–483.
33. Chen X, Xu J, Li B, et al. The Role of Personality and Subjective Exposure Experiences in Posttraumatic Stress Disorder and Depression Symptoms among Children Following Wenchuan Earthquake. *Sci Rep.* 2017;7(1):17223. Published 2017 Dec 8. doi:10.1038/s41598-017-17440-9
34. Pan X, Liu W, Deng G, et al. Symptoms of posttraumatic stress disorder, depression, and anxiety among junior high school students in worst-hit areas 3 years after the Wenchuan earthquake in China. *Asia Pac J Public Health.* 2015;27(2):NP1985-NP1994. doi:10.1177/1010539513488625
35. Fan F, Zhang Y, Yang Y, Mo L, Liu X. Symptoms of posttraumatic stress disorder, depression, and anxiety among adolescents following the 2008 Wenchuan earthquake in China. *J Trauma Stress.* 2011;24(1):44-53. doi:10.1002/jts.20599
36. Tian Y, Wong TK, Li J, Jiang X. Posttraumatic stress disorder and its risk factors among adolescent survivors three years after an 8.0 magnitude earthquake in China. *BMC Public Health.* 2014;14:1073. Published 2014 Oct 15. doi:10.1186/1471-2458-14-1073
37. Ying LH, Wu XC, Lin CD, Chen C. Prevalence and predictors of posttraumatic stress disorder and depressive symptoms among child survivors 1 year following the Wenchuan earthquake in China. *Eur Child Adolesc Psychiatry.* 2013;22(9):567-575. doi:10.1007/s00787-013-0400-3



## The Relationship Between Finger Ratio (2D:4D) and Criminal Behavior in Bipolar Disorder

Elif Emre<sup>1,a,\*</sup>, Sevler Yıldız<sup>2,b</sup>, Suna Aydın<sup>3,c</sup>, Düzgün Şimşek<sup>4,d</sup>, Mehmet Gürkan Gürok<sup>5,e</sup>

<sup>1</sup> Department of Anatomy, Faculty of Medicine, University of Fırat, Elazığ, Türkiye

<sup>2</sup> Department of Psychiatry, Elazığ Fethi Sekin City Hospital, Elazığ, Türkiye.

<sup>3</sup> Department of Cardiovascular Surgery, Elazığ Fethi Sekin City Hospital, Elazığ, Türkiye

<sup>4</sup> Department of Psychiatry, Elazığ Mental Health Hospital, Elazığ, Türkiye

<sup>5</sup> Department of Psychiatry, University of Fırat, Elazığ, Türkiye.

\*Corresponding author

### Research Article

#### History

Received: 16/01/2025

Accepted: 26/03/2025

#### Copyright



This work is licensed under  
Creative Commons Attribution 4.0  
International License

### ABSTRACT

**Objective:** The purpose of this study was to examine the relationship between 2D:4D digit ratio and aggression and impulsivity in manic patients (BP) with and without a history of criminal behavior.

**Materials and Methods:** The study included a total of 106 subjects, which included 41 healthy individuals, 34 bipolar (BP) patients with a history of criminal behavior (CBP) and 31 BP patients who had not engaged in criminal activity (NCBP). All participants were administered a socio-demographic data form, the Buss-Perry Aggression Scale (BAQ), Barratt Impulsiveness Scale-11 (BIS-11) and the Young Mania Rating Scale (YMRS) and 2D:4D ratio measurement.

**Results:** The right hand 2D:4D ratios of BP patients included in the study were significantly lower (p: 0.007) compared to the control group. Moreover, the BAQ scores of BP patients were higher compared to the control group. In CBP patients, both the right hand 2D:4D (p: 0.007) and left hand 2D:4D (p: 0.036) were significantly lower when compared to the control group. Furthermore, the BIS-11 score (p: 0.046) and YMRS (p: 0.008) of CBP patients were significantly higher when compared to NCBP.

**Conclusion:** Based on results, we predict that in the future, the lower 2D:4D ratio in the right and left hand of bipolar manic patients who commit crimes compared to the control group, will guide in advance whether individuals prone to bipolar manic disorder will be involved in criminal activities, utilizing anatomical data (2D:4D) as a potential anatomical marker.

**Keywords:** Bipolar, Crime, Mania, Digit Ratio, 2D:4D.

## Bipolar Bozuklukta Parmak Oranı (2D:4D) ile Suç Davranışı Arasındaki İlişki

### Araştırma Makalesi

#### Süreç

Geliş: 16/01/2025

Kabul: 26/03/2025

#### Telif Hakkı



Bu Çalışma Creative Commons Atıf  
4.0 Uluslararası Lisansı  
Kapsamında Lisanslanmıştır.

### ÖZET

**Amaç:** Bu çalışmanın amacı, suç davranışı öyküsü olan ve olmayan manik hastalarda (BP) 2D:4D rakam oranı ile saldırganlık ve dürtüsellik arasındaki ilişkiyi incelemektir.

**Gereç ve Yöntem:** Çalışmaya 41 sağlıklı birey, suç davranışı öyküsü olan 34 bipolar hasta (CBP) ve suç faaliyetinde bulunmamış 31 BP hastası (NCBP) olmak üzere toplam 106 denek dahil edilmiştir. Tüm katılımcılara sosyo-demografik veri formu, Buss-Perry Saldırganlık Ölçeği (BAQ), Barratt Dürtüsellik Ölçeği-11 (BIS-11) ve Young Mani Derecelendirme Ölçeği (YMRS) uygulanmış ve 2D:4D oranı ölçülmüştür.

**Bulgular:** Çalışmaya dahil edilen BP hastalarının sağ el 2D:4D oranları kontrol grubuna kıyasla anlamlı derecede düşüktü (p:0.007). Ayrıca BP hastalarının BAQ skorları kontrol grubuna kıyasla daha yüksekti. CBP hastalarında hem sağ el 2D:4D (p:0.007) hem de sol el 2D:4D (p:0.036) oranları kontrol grubuna kıyasla anlamlı derecede düşüktü. Ayrıca, CBP hastalarının BIS-11 skoru (p:0.046) ve YMRS (p:0.008) NCBP ile karşılaştırıldığında anlamlı derecede yüksekti.

**Sonuç:** Sonuçlara dayanarak, gelecekte suç işleyen bipolar manik hastaların sağ ve sol ellerindeki 2D:4D oranının kontrol grubuna kıyasla daha düşük olmasının, altın standart olarak anatomik verileri (2D:4D) kullanarak bipolar manik bozukluğa yatkın bireylerin suç faaliyetlerine karışıp karışmayacağı konusunda önceden yol göstereceğini tahmin ediyoruz.

**Anahtar Kelimeler:** Bipolar, Suç, Mani, Rakam Oranı, 2D:4D

<sup>a</sup> eemre@firat.edu.tr

<sup>c</sup> cerrah52@hotmail.com

<sup>e</sup> mggurok@hotmail.com

<sup>b</sup> 0000-0001-5659-3499

<sup>d</sup> 0000-0002-5857-0888

<sup>e</sup> 0000-0001-8998-0743

<sup>b</sup> dr\_sevler@hotmail.com

<sup>d</sup> duzugunsimsek@yahoo.com

<sup>b</sup> 0000-0002-9951-9093

<sup>d</sup> 0009-0002-2260-8255

**How to Cite:** Emre E, Yıldız S, Aydın S, Şimşek D, Gürok MG. The Relationship Between Finger Ratio (2D:4D) and Criminal Behavior in Bipolar Disorder. Cumhuriyet Medical Journal, 2025;47(1):41-48

## Introduction

Bipolar disorder is a psychiatric condition that leads to significant impairment in functioning due to episodes of mania, hypomania and depression.<sup>1</sup> The common features of depressive, manic or hypomanic episodes are unusual differences in a person's mood. This difference can be seen as reluctance, lack of pleasure, dysphoria in the depressive episode or euphoria or irritability in the manic episode. The condition in which manic symptoms are milder in terms of duration and severity is called "hypomania".<sup>2</sup> Patients with bipolar disorder demonstrate heightened impulsivity and aggression, particularly during manic episodes.<sup>3</sup> Impulsive and aggressive behaviors during manic episodes lead to negative impacts on the lives of patients and those around them, as patients have a tendency towards self-harm and criminal activities.<sup>4</sup> Furthermore, physical violence during manic episodes increases in severity in line with the intensity of the manic attack.<sup>5, 6</sup> Studies have shown that during manic episodes patients frequently display hostility and aggression towards unfamiliar objects, others and themselves.<sup>7</sup>

It has been demonstrated that traits such as aggression, impulsivity, novelty-seeking and competitiveness, which are typical masculine behaviors, are inversely related to the 2D:4D ratio.<sup>8</sup> The relationship between anthropometric measurements and diseases has been known for centuries. However, recent studies in particular have shown that there may be a connection between the 2D:4D finger ratio and psychiatric diseases. The association of the 2D:4D ratio with many diseases has been reported in numerous studies.<sup>9</sup> The 2D:4D ratio (Figure 1), which can be seen in different variations, has been shown to be higher in patients with bipolar disorder, a major psychiatric disorder, compared to healthy controls.<sup>10</sup> Therefore, it is also calculated in psychiatric diseases to get an idea about fetal hormonal exposure.<sup>11</sup> In a study conducted in patients with schizophrenia, the 2D:4D ratio of patients was found to be significantly higher compared to healthy controls and this was said to be related to abnormal cerebral changes in the pathogenesis of the disease.<sup>12</sup> In a study conducted in patients with depression, it was reported that the 2D:4D figure ratios were not related to the severity of depression, thus depression was associated with the absence of gender differences in the 2D:4D ratio.<sup>13</sup>

To the best of knowledge, there has been no study yet comparing the 2D:4D ratio in manic patients with and without a criminal history. Scales used in psychiatry can determine the diagnosis and severity of diseases.<sup>14</sup> Again, the severity of psychiatric illness can provide information about a person's tendency to harm others and themselves.<sup>15</sup> In some scales used in patients with bipolar disorder, significant differences were observed in those who had committed a crime compared to those who had not.<sup>16</sup> Therefore, the study reported here investigated the relationship between the 2D:4D ratio and aggression and impulsivity in manic patients with and without a criminal history using the Buss-Perry Aggression Questionnaire

(BAQ), Barratt Impulsiveness Scale-11 (BIS-11), and the Young Mania Rating Scale (YMRS).

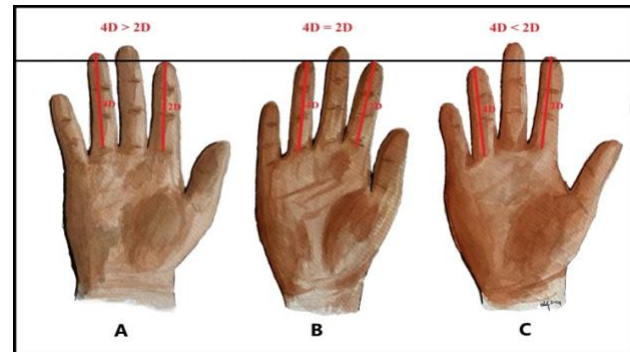

**Figure 1.** Different variations and appearance of 2D:4D finger ratio in humans. This figure is hand-drawn by the first author (EE). A shorter (A) 2D:4D ratio in men is genetically considered a normal variation, while an equal (B) or longer (C) 2D:4D ratio is considered to be a pathological variation

## Materials and Methods

### Ethical Considerations

The study was approved by the Non-Interventional Local Ethics Committee of Firat University under reference number 2023/13-06 (Meeting Date: 27.09.2023). Written informed consent from guardians was obtained prior to study commencement. The study complied with the Helsinki Declaration.

### The Study Population, Place and Time of Research

It included 41 healthy individuals without psychiatric diagnoses, 34 manic patients with criminal involvement and 31 manic patients without criminal involvement respectively admitted to the Elazig City Hospital forensic psychiatry service and the Elazig Mental Health and Diseases Hospital psychiatry service between the dates of 01.10.2023 and 30.11.2023.

### Data Collection

Evaluation and diagnosis were performed by a senior psychiatric specialist according to the Diagnostic and Statistical Manual of Mental Disorders 5th edition (DSM-5) criteria for manic episodes of bipolar disorder.<sup>1</sup>

Exclusion criteria included being under 18 years of age, having any congenital anomaly including bones, finger deformities, or any serious organic condition affecting skin tone. A healthy control group was also included in the study. They were subject to the same exclusion criteria applied to patients with manic episodes of bipolar disorder. The healthy control group was in good physical and mental condition, without any current or past neurological or psychiatric illness, endocrinological abnormalities, or congenital anomalies related to the bones.

### 2D:4D ratio measurements

Finger measurements were made according to a previously illustrated and described method<sup>9</sup> where individuals were asked to place the dorsal side of their hands on a firm flat surface with the palmar side facing upwards and as open as possible. The measurement was taken from the midpoint of the proximal line that separates the finger root from the palm to the distal end of the finger when the thumb was in slight extension and the other four fingers in adduction (Figure 2). Both the second and fourth fingers were measured three times by two independent assessors who were blind to the group identity of the subjects and the average of the measurements was obtained. The digit ratios were then calculated by dividing the lengths of the second and fourth fingers to obtain the final result. All measurements were performed using a standard digital caliper (Valkyrie 150 x 0.01 mm Digital Stainless Steel Electronic Precision Caliper) with a calibrated precision of 0.01 mm.

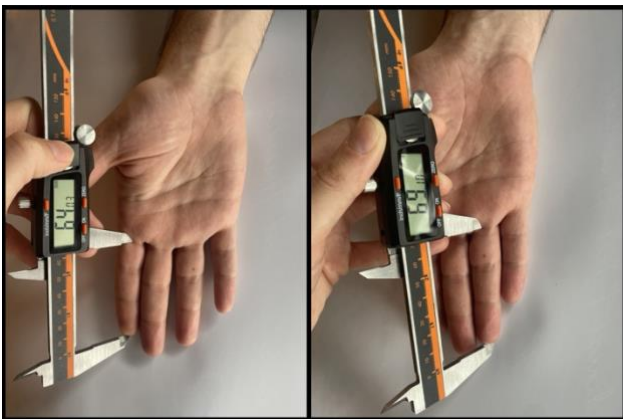

**Figure 2.** Representative image of the measurement of 2D:4D finger ratio with a caliper for individuals participating in the study

### Scales used in the study

The Sociodemographic and Clinical Data Form,<sup>17</sup> Barratt Impulsiveness Scale (BIS-11)<sup>18</sup> and Buss Perry Aggression Scale (BPAS)<sup>19</sup> were applied to all participants, while the Young Mania Rating Scale (YMRS)<sup>20</sup> was administered to individuals diagnosed with bipolar manic disorder.

**Sociodemographic and Clinical Data Form:** This form is semi-structured and includes sociodemographic information such as age, marital status, place of residence, education level, occupation and clinical data such as disease and treatment duration.<sup>17</sup>

**Barratt Impulsiveness Scale:** The BIS-11 scale developed by Patton *et al.* is a self-report scale developed to measure impulsiveness.<sup>18</sup> Güleç *et al.* carried out both the scale's translation into Turkish and a validity and reliability evaluation. There are three sub-factors in the scale: attentional impulsiveness, motor impulsiveness and non-planning impulsiveness.<sup>21</sup>

**Buss Perry Aggression Scale:** BPAS is a self-report scale consisting of 29 statements developed to determine level of aggression.<sup>19</sup> It assesses physical aggression,

verbal aggression and anger and hostility sub-dimensions. The adaptation to Turkish was done by Evren *et al.*<sup>22</sup>

**Young Mania Rating Scale:** This scale was prepared by Young *et al.* to measure severity and change of manic state.<sup>20</sup> It consists of 11 items, each measuring five levels of severity, evaluated by the interviewer. A validity and reliability study was conducted in Turkish.<sup>23</sup>

### Statistical Analysis

Statistical Package for the Social Sciences (SPSS) version 21.0 was used for statistical analyses. Power analysis was used to estimate a sample size. The calculation ensured 95% statistical power at a significance level (alpha error probability) of 0.05. To achieve sufficient statistical power, a total of 106 samples were included, with a projected required sample size of 100. Categorical variables are given as frequencies and percentages. The normality of continuous variable distributions was assessed using the Kolmogorov-Smirnov test and histograms. Numeric parameters that exhibited a normal distribution were compared between groups using Student's *t*-test or one-way analysis of variance, while data that were not normally distributed were analyzed using either the Mann-Whitney U or Kruskal-Wallis test. Categorical variables were compared using chi-square or Fisher's exact test when appropriate. The strength of the relationship between two variables was evaluated using Spearman or Pearson correlation coefficients. A *p*-value < 0.05 was considered to indicate statistical significance.

### Results

A total 106 male participants were included in the study, comprising 41 healthy controls, 34 manic patients with criminal involvement and 31 manic patients without criminal involvement. The average age of all participants was 35 years (range 20-70). Controls had a higher level of education, were more likely to be married, live in an urban area and had a profession when compared to bipolar patients. The prevalence of smoking was higher in bipolar patients compared to controls.

No significant differences were found between the groups in terms of other chronic diseases and alcohol consumption. The Buss-Perry Aggression Scale score was significantly higher in all bipolar manic patients compared to controls, while there was no significant difference between criminal and non-criminal bipolar patients.

BIS-11 scores were significantly higher for criminal bipolar manic patients compared to controls (*p*: 0.003) and non-criminal bipolar manic patients (*p*: 0.046). The YMRS score was significantly higher in criminal bipolar manic patients compared to non-criminal patients (*p*: 0.008).

In non-criminal patients, there was a correlation between the 2D:4D ratio of the right hand and both the Barratt Aggression Questionnaire (*p*: 0.020) and BIS-11 (*p*: 0.009) scores (Table 1). When bipolar manic patients were divided into two groups (criminal and non-criminal), there were no significant differences between the groups for



age, antipsychotic medication use, suicide attempts, duration of illness and Buss-Perry Aggression Scale (BAQ) score. Detailed results regarding the sociodemographic and clinical characteristics of the patients are given in Table 2.

Regardless of criminal history, the 2D:4D ratio of the right hand was found to be significantly lower in patients

compared to the control group and statistically significant differences were found between the control and criminal manic patients in both the right and left 2D:4D ratios ( $p = 0.007$  and  $p = 0.036$ , respectively) (Table 3). The association between the patients' right and left 2D:4D ratios, age and scale scores is given in Table 1.

**Table 1.** Comparison of the relationship between the 2D/4D ratio of the right and left hand of manic individuals with bipolar disorder who have and have not committed crimes, with age, disease duration and some parameters

Parameters		All patients (n = 65)		Committed crimes (n = 34)		Not committed crimes (n = 31)	
		Right 2D/4D ratio	Left 2D/4D ratio	Right 2D/4D ratio	Left 2D/4D ratio	Right 2D/4D ratio	Left 2D/4D ratio
Right 2D/4D ratio	r		0.467		0.583		0.200
	p-value		< 0.001		< 0.001		0.281
Left 2D/4D ratio	r	0.467		0.583		0.200	
	p-value	< 0.001		< 0.001		0.281	
Age	r	-0.011	0.002	0.114	-0.023	-0.034	0.108
	p-value	0.908	0.986	0.520	0.895	0.856	0.562
Buss-Perry Aggression Scale	r	-0.073	-0.070	-0.266	-0.025	0.414	0.015
	p-value	0.458	0.477	0.128	0.887	0.020	0.937
Barratt Impulsiveness Scale	r	0.035	0.035	-0.155	0.009	0.462	0.097
	p-value	0.724	0.720	0.382	0.958	0.009	0.605

**Table 2.** Comparison of demographic characteristics of manic individuals with bipolar disorder who have either committed or not committed crimes

Parameters	Control (n = 41) <sup>a</sup>	Committed crimes (n = 34) <sup>b</sup>	Not committed crimes (n = 31) <sup>c</sup>	p
Age, median (min-max)	35 (23-54)	35 (20-63)	36 (25-77)	0.705
Marital Status				
Single, n (%)	10 (24.4)	22 (64.7)	26 (83.9)	< 0.001 <sup>ab,ac</sup>
Married, n (%)	31 (75.6)	12 (35.3)	5 (16.1)	
Education				
Illiterate, n (%)	0 (0)	4 (11.8)	5 (16.1)	< 0.001 <sup>ab,ac</sup>
Primary school, n (%)	0 (0)	18 (52.9)	16 (51.6)	
High school, n (%)	13 (31.7)	8 (23.5)	7 (22.6)	
University, n (%)	28 (68.3)	4 (11.8)	3 (9.7)	
Place of residence				
Rural area, n (%)	0 (0)	9 (26.5)	10 (32.3)	< 0.001 <sup>ab,ac</sup>
Urban area, n (%)	41 (100)	25 (73.5)	21 (67.7)	
Working status				
Unemployed, n (%)	0 (0)	22 (64.7)	24 (77.4)	< 0.001 <sup>ab,ac</sup>
Employed, n (%)	41 (100)	12 (35.3)	7 (22.6)	
Other Chronic Illness				
Yes, n (%)	5 (12.2)	9 (26.5)	2 (6.5)	0.032 <sup>bc</sup>
No, n (%)	36 (87.8)	25 (73.5)	29 (93.5)	
Smoking				
Yes	16 (39)	29 (85.3)	28 (90.3)	< 0.001 <sup>ab,ac</sup>
No	25 (61)	5 (14.7)	3 (9.7)	
Alcohol consumption				
No	36 (87.8)	29 (85.3)	27 (87.1)	0.948
Yes	5 (12.2)	5 (14.7)	4 (12.9)	

Antipsychotic drug use				
No	41 (100)	4 (11.8)	2 (6.5)	< 0.001 <sup>ab,ac</sup>
Yes	0 (0)	30 (88.2)	29 (93.5)	
Suicide attempt				
No, <i>n</i> (%)	41 (100)	28 (82.4)	30 (96.8)	0.107 <sup>bc</sup>
Yes, <i>n</i> (%)	0 (0)	6 (17.6)	1 (3.2)	
Duration of illness, years, median (min-max)	-	9 (0.5-40)	10 (0.5-30)	0.201 <sup>bc</sup>
Young mania rating scale, median (min-max)	-	7 (2-11)	4 (1-12)	0.008 <sup>bc</sup>
Buss–Perry Aggression Questionnaire, <i>n</i> ± SD	54.02 ± 12.70	77.26 ± 16.00	70.81 ± 12.44	< 0.001 <sup>ab,bc</sup>
Barratt Impulsiveness Scale (BIS-11), median (min-max)	52 (31-79)	63 (37-111)	58 (39-74)	0.003 <sup>ab</sup> 0.046 <sup>bc</sup>

Categorical variables are given as *n* (%), normally distributed variables are given as mean ± standard deviation while skewed distributions are given as median (min-max), min:minimum, max:maximum

**Table 3.** Right and left hand 2D/4D ratios in the controls and patients with bipolar disease groups

Parameters	Control ( <i>n</i> = 41)	Patients with bipolar disease ( <i>n</i> = 65)		<i>p</i>
Right 2D/4D ratio, <i>n</i> ± SD	0.994 ± 0.334 <sup>a</sup>	0.974 ± 0.399 <sup>b</sup>		0.007 <sup>ab</sup>
		Committed crimes ( <i>n</i> = 34)	Not committed crimes ( <i>n</i> = 31)	0.007 <sup>ac</sup> 0.281 <sup>ad</sup> 0.334 <sup>cd</sup>
		0.968 ± 0.385 <sup>c</sup>	0.981 ± 0.407 <sup>d</sup>	
Left 2D/4D ratio, <i>n</i> ± SD	0.986 ± 0.328 <sup>a</sup>	0.973 ± 0.380 <sup>b</sup>		0.063 <sup>ab</sup>
		Committed crimes ( <i>n</i> = 34)	Not committed crimes ( <i>n</i> = 31)	0.036 <sup>ac</sup> 0.797 <sup>ad</sup> 0.198 <sup>cd</sup>
		0.965 ± 0.383 <sup>c</sup>	0.981 ± 0.364 <sup>d</sup>	

*p*\* : *p*-values in each group after *post-hoc* test, normally distributed variables are given as mean ± standard deviation

## Discussion

The association between anatomical measurements and diseases has long been recognized.<sup>24</sup> This study revealed for the first time a relationship between the 2D:4D ratio and crime. It was found that the 2D:4D ratio of both the right and left hand of manic patients who committed crimes was lower than that of healthy controls, but there was no significant difference between manic patients who did not commit crimes. The level of aggression was higher in manic patients compared to the healthy control group, but there was no difference in aggression level between those who committed crimes and those who did not. Similarly, impulsivity levels were higher in manic patients who committed crimes compared to manic patients who did not, as well as the healthy control group.

It is known that patients with bipolar disorder are prone to commit crimes due to increased energy, grandiose thoughts and delusions during the manic period.<sup>25</sup> However, it has been observed that not all manic patients commit crimes.<sup>26</sup> Recent studies have focused on

the potential effects of the 2D:4D ratio on mental illnesses such as schizophrenia, depression, anxiety and alcohol dependence.<sup>12, 13, 27, 28</sup> Meta-analyses generally show that psychiatric patients have lower 2D:4D compared to healthy controls.<sup>11</sup> In a study comparing the 2D:4D ratio of 70 bipolar disorder patients with 70 in a healthy control group, higher right hand 2D:4D ratios were found in patients compared to controls. When compared by gender, both right and left 2D:4D ratios in male patients were significantly higher compared to males in the control group. However, in female bipolar disorder patients, no difference in right or left 2D:4D ratio was observed compared to controls. It is thought that the high 2D:4D ratio in the right hand is associated with the presence of bipolar disorder in males.<sup>29</sup>

Another study, however, found no disparity in the 2D:4D ratios between bipolar disorder patients and controls, or between groups of patients with and without histories of suicide attempts.<sup>30</sup> In the current study, which focused exclusively on male participants, it was discovered that manic patients had lower right and left 2D:4D ratios in comparison to healthy controls.

Nevertheless, no variances were observed in the 2D:4D ratio between manic patients who had committed crimes and those who had not. In the current study, a greater level of aggression was observed in manic patients compared to a healthy control group. However, no significant difference was found in aggression between patients who either had or had not committed a crime. Prior research has shown that aggression levels are elevated in manic patients during the acute phase<sup>31</sup>, but the specific mechanism behind this phenomenon remains unclear. Thus, it is proposed that the correlation between criminal behavior and low 2D:4D ratios may be a potentially useful measure.

Individuals with a prior history of criminal behavior during manic episodes exhibited a higher severity of mania compared to patients without a criminal history. However, no significant difference in aggression level was found between the two groups, but there was a significant difference in impulsivity level. Additionally, there was no difference in suicide attempts between patients with and without a criminal history. Impulsivity is positively correlated with aggression level<sup>32, 33</sup>, but sometimes two different impulsive groups may show different levels of aggressive behavior.<sup>34</sup> Nonetheless, it has been recorded that divergent impulsive groups may exhibit different levels of aggressive behavior, potentially leading to variations in criminal inclinations within the same patient cohort.

The healthy control group tended to possess higher levels of education, were married, resided in urban areas and were employed in contrast to individuals with bipolar manic disorder. Bipolar disorder and its associated episodes have a detrimental impact on various dimensions of quality of life, including education and employment status.<sup>35, 36</sup> Although the prevalence of smoking was higher in manic patients compared to the control group, there was no significant difference between the groups in terms of alcohol use. Smoking is a common addiction in bipolar disorder patients due to chronic mood instability and limited social support.<sup>37</sup> While alcohol use is common in manic patients<sup>38</sup>, comparable levels of alcohol use were observed in all three groups. Although a low 2D:4D ratio alone is not sufficient to diagnose bipolar disorder manic episodes, when used in conjunction with other indicators, it can lend support to such a diagnosis.

#### Limitations and Strengths of the Research

One of the main limitations of this study is that women were not included in the study. Because women have a menstrual cycle. As known, the menstrual cycle is divided into three phases: follicular phase ( days 1-14; before release of the egg); ovulation phase ( day 14; egg release), and luteal phase (days 14-28; after egg release).<sup>39</sup> The *menstrual cycle* has a significant *impact* on a woman's *mood and emotions*<sup>40</sup>. Measurements (e.g. YMRS) used here will be possibly affected by *manic symptoms* and emotional state (Young et al, 1978).<sup>20</sup> Therefore, only men were included in the study. In the

future, beside this pioner research, a new important study can be also designed in this context, taking into account 3 different phases of the menstrual cycle.<sup>41, 42</sup> This is important limitation of the study. However, despite of above limitation, a low 2D:4D ratio may help with prediction of male individuals at high risk of developing bipolar disorder manic episodes in the future, the prediction of criminal tendency before the commission of the crime and the development of new strategies. Since the social, environmental, and biological factors of individuals may also influence criminal tendency, the 2D:4D ratio alone may be insufficient to explain the predisposition to criminal behavior. Therefore, we believe that it would be beneficial for future studies to incorporate individuals' social and environmental factors.

#### Conclusion

It is anticipated that finger length measurement, a non-invasive, inexpensive and applicable method, may facilitate the recognition of individuals predisposed to committing crimes before actually committing them as manic patients. These findings suggest that it may be possible to forecast an individual's propensity for criminal activity based on this physical characteristic. This, in turn, could assist in upholding social order and averting legal proceedings. It should be noted, however, that the current data does not differentiate between individuals with bipolar manic depression who commit crimes and those who do not. This is an important consideration moving forward.

#### Acknowledge

The authors would like to express their gratitude to individuals that participated in this study. We thank ResearchSquare for helping us reach more colleagues and improve the quality of our articles through feedback.

#### Conflicts of interest

The authors declare no potential conflicts of interest with respect to the research, authorship and/or publication of this article.

#### Authorship Contribution

EE, SY, SA, DS and MGG designed the study and developed the survey. EE and SY undertook the statistical analysis, and SA and MGG advised on the statistical approach. EE wrote the first draft of the manuscript. All authors contributed to and have approved the final manuscript

#### Funding

This research received no external funding.

#### Ethical Approval Statement

Non-Interventional Local Ethics Committee of Firat University under reference number 2023/13-06 (Meeting Date: 27.09.2023).

## References

- 1- APA, American Psychiatric Association. Diagnostic and statistical manual of mental disorders (DSM-5), 2013.
- 2- Guy MG. Bipolar disorder. *Medicine*. 2024; 52, 481-484. doi:10.1016/j.mpmed.2024.06.003
- 3- Drachman R, Colic L, Sankar A, et al. Rethinking "aggression" and impulsivity in bipolar disorder: Risk, clinical and brain circuitry features. *J Affect Disord*. 2022; 303: 331-339.
- 4- Dome P, Rihmer Z, Gonda X. Suicide risk in bipolar disorder: a brief review. *Medicina (Kaunas)*. 2019; 55(8): 403. doi: 10.3390/medicina55080403.
- 5- Li X, Gao Y, Liu Y, Wang Y, Wu Q. Clinical markers of physical violence in patients with bipolar disorder in manic states. *Risk Manag Healthc Policy*. 2023; 16: 1-10.
- 6- Ryles F, Meyer TD, Adan-Manes J, MacMillan I, Scott J. A systematic review of the frequency and severity of manic symptoms reported in studies that compare phenomenology across children, adolescents and adults with bipolar disorders. *Int J Bipolar Disord*. 2017; 5(1): 4.
- 7- Dailey MW, Saadabadi A. *Mania*. StatPearls Publishing, Treasure Island (FL); 2023
- 8- Canan F, Karaca S, Düzgün M, et al. The relationship between second-to-fourth digit (2d:4d) ratios and problematic and pathological internet use among turkish university students. *J Behav Addict*. 2017; 6(1): 30-41. doi: 10.1556/2006.6.2017.019.
- 9- Emre E, Aydın S, Yıldız S. An overview of the association between the second and fourth finger ratio (2d/4d) and diseases. *Academic Research and Reviews in Health Sciences-Chapter 7*. Platanus Publishing, 103-121, 2023.
- 10- Tegin C, Canan F, El-Mallakh RS. The 2nd to 4th digit ratios (2D:4D) in patients with bipolar disorder. *J Affect Disord*. 2019; 259: 27-30.
- 11- Fusar-Poli L, Rodolico A, Sturiale S, et al. Second-to-Fourth Digit Ratio (2D:4D) in Psychiatric Disorders: A Systematic Review of Case-control Studies. *Clin Psychopharmacol Neurosci*. 2021 Feb 28;19(1):26-45. doi: 10.9758/cpn.2021.19.1.26.
- 12- Han Y, Deng W, Lei W, et al. Association between the 2D: 4D ratio and schizophrenia. *Journal of International Medical Research*. 2020; 48: 0300060520929148.
- 13- Sanwald S, Widenhorn-Müller K, Wernicke J, Sindermann C, Kiefer M, Montag C. Depression Is Associated With the Absence of Sex Differences in the 2D:4D Ratio of the Right Hand. *Front Psychiatry*. 2019; 16: 10:483. doi:10.3389/fpsy.2019.00483
- 14- Egger ST, Bobes J, Theodoridou A, Seifritz E, Vetter S. Assessing the severity of psychiatric disorders using the Health of the Nation Outcome Scales: An equipercentile linking analysis. *Aust N Z J Psychiatry*. 2020; 54:1192-1199.
- 15- Fazel S, Vazquez-Montes MDL, Molero Y, et al. Risk of death by suicide following self-harm presentations to healthcare: development and validation of a multivariable clinical prediction rule (OxSATS). *BMJ Ment Health*. 2023; 26: e300673.
- 16- Najafzadeh, MJ, Ghazanfari Pour S, Divsalar P. Aggression in schizophrenia, bipolar and major depression disorder. *J Aggress Confl Peace Res*. 2023; 15: 349-359. doi: 10.1108/JACPR-11-2022-0756.
- 17- Sırlıer Emir B, Kazğan A, Kurt O, Yıldız S. Sociodemographic Characteristics of Persons Treated in the High Security Forensic Psychiatry Service: A Retrospective Study. *Med Records*. 2022; 4: 73-80.
- 18- Patton JH, Stanford MS, Barratt ES. Factor structure of the Barratt impulsiveness scale. *J Clin Psychol*. 1995; 51: 768-774.
- 19- Buss AH, Perry M. The Aggression Questionnaire. *J Pers Soc Psych*. 1992; 63: 452-459.
- 20- Young RC, Biggs JT, Ziegler VE, Meyer DA. A Rating Scale for Mania: Reliability, Validity and Sensitivity. *Br J Psychiatry*. 1978; 133(5): 429-435.
- 21- Güleç H, Tamam L, Yazıcı Güleç M, et al. Barratt Dürtüsellik Ölçeği -11 (BIS11)' nin Türkçe uyarlamasının psikometrik özellikleri. *Psychometric properties of Turkish version of BIS-11*. *Bull Clin Psychopharmacol*. 2008; 18: 251-258.
- 22- Evren C, Cınar O, Güleç H, Çelik S, Evren B. The validity and reliability of the Turkish version of the Buss-Perry's Aggression Questionnaire in male substance dependent inpatients. *Dusunen Adam Journal of Psychiatry and Neurological Sciences*, 2011; 24, 283-295. doi:10.5350/DAJPN2011240404
- 23- Karadağ F, Oral T, Yalçın FA, Erten E. Reliability and validity of Turkish translation of Young Mania Rating Scale. *Turk Psikiyatri Dergisi*. 2002;13(2): 107-114.
- 24- Steinkamp RC. Body composition in relation to disease. *Am J Public Health Nations Health*. 1968, 58 (3): 473-476. doi:10.2105/AJPH.58.3.473
- 25- Lake CR. Hypothesis: grandiosity and guilt cause paranoia; paranoid schizophrenia is a psychotic mood disorder; a review. *Schizophr Bull*. 2008; 34(6): 1151-62. doi:10.1093/schbul/sbm132.
- 26- Ghiasi N, Azhar Y, Singh J. Psychiatric illness and criminality. In *StatPearls [internet]*. StatPearls Publishing. 2023.
- 27- Evardone M, Alexander GM. Anxiety, sex-linked behaviors, and digit ratios (2D:4D). *Arch Sex Behav*. 2009; 38(3):442-55. doi: 10.1007/s10508-007-9260-6 doi:10.1007/s10508-007-9260-6
- 28- Lenz B, Mühle C. Cohort Study on Substance Use Risk Factors; Kornhuber, J. Lower digit ratio (2D:4D) in alcohol dependence: Confirmation and exploratory analysis in a population-based study of young men. *Addict Biol*. 2020; 25(4). doi: 10.1111/adb.12815.
- 29- Kılıç F, Işık Ü, Demirdaş A, İnci HE. Investigation of second to fourth finger length ratio (2D:4D) in patients with bipolar disorder. *Braz J Psychiatry*. 2020; 42(6):617-620.
- 30- Sırlıer EB, Yıldız S, Kılıçaslan KA, et al. Inflammation Markers in Patients with Bipolar Disorder Who Have Committed Offenses and Their Relationship with Criminal Behavior. *Medicina*. 2023; 59(10), 1725.
- 31- Ballester J, Goldstein T, Goldstein B, et al. Is bipolar disorder specifically associated with aggression? *Bipolar Disord*. 2012, 14(3):283-90.
- 32- Swann AC, Moeller FG, Steinberg JL, Schneider L, Barratt ES, Dougherty DM. Manic symptoms and impulsivity during bipolar depressive episodes. *Bipolar Disord*. 2007; 9(3):206-12. doi:10.1111/j.1399-5618.2007.00357.x.

- 33- Yu C, Zhang J, Zuo X, Lian Q, Tu X, Lou C. Correlations of impulsivity and aggressive behaviours among adolescents in Shanghai, China using bioecological model: cross-sectional data from Global Early Adolescent Study. *BMJ Open*. 2021; 15;11(7). doi:10.1136/bmjopen-2020-043785.
- 34- Gauthier KJ, Furr RM, Mathia CW, Marsh-Richard DM, Dougherty DM. Differentiating impulsive and premeditated aggression: self and informant perspectives among adolescents with personality pathology. *J Pers Disord*. 2009, 23(1):76-84.
- 35- Azorin JM, Lefrere A, Belzeaux R. The Impact of Bipolar Disorder on Couple Functioning: Implications for Care and Treatment. A Systematic Review. *Medicina (Kaunas)*. 2021, 29; 57(8):771.
- 36- Rowland TA, Marwaha S. Epidemiology and risk factors for bipolar disorder. *Ther Adv Psychopharmacol*. 2018; 26; 8(9): 251-269. doi:10.1177/2045125318769235.
- 37- Heffner JL, Strawn JR, DelBello MP, Strakowski SM, Anthenelli RM. The co-occurrence of cigarette smoking and bipolar disorder: phenomenology and treatment considerations. *Bipolar Disord*. 2011; 13(5-6):439-53. doi: 10.1111/j.1399-5618.2011.00943.x.
- 38- Sonn SC, Brady KT. Bipolar Disorder and Alcoholism. *Alcohol Res Health*. 2002; 26(2):103–8.
- 39- Teixeira ALDS, Fernandes Júnior W, Marques FA, Lacio MLD, Dias MRC. Influence of different phases of menstrual cycle on flexibility of young women. *Revista Brasileira de Medicina do Esporte*. 2012; 18: 361-364. doi: 10.1590/S1517-86922012000600002.
- 40- Pletzer B, Noachtar I. Emotion recognition and mood along the menstrual cycle. *Horm Behav*. 2023; 154: 105406.
- 41- Rasgon N, Bauer M, Glenn T, Elman S, Whybrow PC. Menstrual cycle related mood changes in women with bipolar disorder. *Bipolar disord*. 2003; 5(1): 48-52. doi: 10.1034/j.1399-5618.2003.00010.x.
- 42- Teatero ML, Mazmanian D, Sharma V. Effects of the menstrual cycle on bipolar disorder. *Bipolar disord*. 2014; 16(1): 22-36.



## Very Early Use of Clozapine in a Case of Very Early-Onset Schizophrenia

Beyza Nur Karal<sup>1,a,\*</sup>, Yahya Esad Özdemir<sup>2,b</sup>, Ali Karayağmurlu<sup>1,c</sup>

<sup>1</sup> Child and Adolescent Psychiatry, Istanbul Faculty of Medicine, Istanbul University, Istanbul, Türkiye.

<sup>2</sup> Child and Adolescent Psychiatry, Faculty of Medicine, Istanbul Medeniyet University, Istanbul, Türkiye.

\*Corresponding author

### Case Report

#### History

Received: 02/11/2024

Accepted: 06/01/2025

#### Copyright



This work is licensed under  
Creative Commons Attribution 4.0  
International License

### ABSTRACT

Schizophrenia is a chronic disorder that affects 1% of the population and causes serious impairment in functioning. If symptoms associated with schizophrenia begin before the age of eighteen, it is called early-onset schizophrenia (EOS), and if it starts before the age of thirteen, it is called very early-onset schizophrenia (VEOS). Although there are many studies on the prevalence and risk factors of schizophrenia in the adult population, there are not enough studies yet on VEOS. Although the number of studies on this topic is limited, it is known that these cases have a more severe course than adult-onset schizophrenia. In very early-onset schizophrenia, it has been determined that the loss of gray matter continues from the onset of the disease, which accelerates during adolescence. Early diagnosis of cases and early initiation of treatment are critical, as neurocognitive deterioration is more rapid and severe. Also, treatment resistance is not uncommon. Clozapine, which has never been the first choice in the pediatric population due to its possible adverse effects, should be considered as a treatment option in these cases. In this paper, we will present the successful management of a 10-year-old boy with schizophrenia using clozapine. Following clozapine treatment, the patient's psychotic symptoms considerably decreased and there were no severe side effects. There was a significant improvement in the patient's daily functionality. It would be useful for clinicians to keep in mind clozapine, which is not a frequently used agent in the child-adolescent population, as a treatment option in treatment-resistant VEOS cases.

**Keywords:** Şizofreni, Klozapin, Çocuk, Ergen

## Çok Erken Başlangıçlı Şizofreni Vakasında Klozapinin Çok Erken Kullanımı

### Olgu Sunumu

#### Süreç

Geliş: 02/11/2024

Kabul: 06/01/2025

#### Telif Hakkı



Bu Çalışma Creative Commons Atf  
4.0 Uluslararası Lisansı  
Kapsamında Lisanslanmıştır.

### ÖZET

Şizofreni toplumun %1'ini etkileyen ve işlevsellikte ciddi bozulmalara neden olan kronik bir hastalıktır. Şizofreni ile ilişkili belirtiler on sekiz yaşından önce başlıyorsa erken başlangıçlı şizofreni (EBŞ), on üç yaşından önce başlıyorsa çok erken başlangıçlı şizofreni (ÇEBŞ) olarak adlandırılmaktadır. Erişkin popülasyonda şizofreninin yaygınlığı ve risk faktörlerini araştıran pek çok çalışma olmasına rağmen ÇEBŞ ile ilgili henüz yeterli çalışma bulunmamaktadır. Bu konuyla ilgili çalışma sayısı sınırlı olsa da bu vakaların erişkin başlangıçlı şizofreniye göre daha ağır seyrettiği bilinmektedir. Çok erken başlangıçlı şizofrenide gri madde kaybının hastalığın başlangıcından itibaren devam ettiği, ergenlik döneminde ise hızlandığı tespit edilmiştir. Nörobilişsel bozulma daha hızlı ve şiddetli olduğundan, vakaların erken tanısı ve tedaviye erken başlanması kritik öneme sahiptir. Ayrıca tedavi direnci de nadir değildir. Muhtemel istenmeyen etkileri sebebiyle hiçbir zaman pediatrik popülasyonda birinci tercih olmayan klozapin, bu olgularda tedavi seçeneği olarak akla gelmelidir. Bu yazıda 10 yaşındaki şizofreni hastasının klozapin ile başarılı tedavisini sunacağız. Klozapin tedavisinden sonra ciddi bir yan etki görülmedi ve hastanın psikotik semptomları önemli ölçüde geriledi. Hastanın günlük işlevselliğinde anlamlı bir düzelme oldu. Çocuk-ergen popülasyonunda kullanımı sık olmayan bir ajan olan klozapinin, tedaviye dirençli ÇEBŞ vakalarında bir tedavi seçeneği olarak klinisyenler tarafından akılda tutulması yararlı olacaktır.

**Anahtar Kelimeler:** Schizophrenia, Clozapine, Child, Adolescent

<sup>a</sup> beyzanurkaral@gmail.com

<sup>id</sup> 0000-0003-4281-6211

<sup>b</sup> yahyaesad@gmail.com

<sup>id</sup> 0000-0002-9986-6159

<sup>c</sup> dralikarayağmurlu@gmail.com

<sup>id</sup> 0000-0001-5464-2891

**How to Cite:** Karal BN, Özdemir YE, Karayağmurlu A. Very Early Use of Clozapine in a Case of Very Early-Onset Schizophrenia, Cumhuriyet Medical Journal. 2025; 47(1): 49-51

## Introduction

Schizophrenia is a chronic disorder that affects 1% of the population and causes serious impairment in functioning.<sup>1</sup> If symptoms associated with schizophrenia begin before the age of eighteen, it is called early-onset schizophrenia (EOS), and if it starts before the age of thirteen, it is called very early-onset schizophrenia (VEOS).<sup>2</sup> Although there are many studies on the prevalence and risk factors of schizophrenia in the adult population, there are not enough studies yet on VEOS.

The course of schizophrenia may exhibit more severe in early-onset cases.<sup>2,3</sup> In very early-onset schizophrenia, it has been determined that the loss of gray matter continues from the onset of the disease, which accelerates during adolescence.<sup>4</sup> Early diagnosis of cases and early initiation of treatment are critical, as neurocognitive deterioration is more rapid and severe.<sup>5,6</sup>

Second-generation antipsychotics are considered the first-line treatment option for children and adolescents with early-onset schizophrenia.<sup>7</sup> But approximately 20-30% of patients with schizophrenia are unresponsive to treatment.<sup>8,9</sup> Treatment-resistant schizophrenia refers to patients with schizophrenia who, despite two different trials of antipsychotics at the required dose and for the required duration, continue to exhibit poor functioning with moderate to severe positive or negative symptoms or disorganization over an extended period of time.<sup>10</sup> Clozapine is a potent antipsychotic agent used in treatment-resistant schizophrenia cases.<sup>11</sup> Still, considering its adverse effects, it is not used as the first choice.<sup>2</sup> In addition, there is no FDA approval or treatment guidance on the use of clozapine in pediatric population.<sup>12,13</sup>

There is a limited number of case reports in the literature regarding the use of clozapine in EOS cases. Because VEOS cases are even rarer than EOS cases, there are much fewer case reports of clozapine use. Therefore, in this paper, successful treatment with clozapine in a ten-year-old boy with a diagnosis of treatment-resistant VEOS will be presented.

## Case

A 10-year-old boy was brought to our clinic by his family. His symptoms were persecutory delusions, grandiose delusions, self-talk, disorganized behaviors, decreased communication, negativism, and agitation. The parents said that these complaints had been present for about a year. The boy, was no longer able to go to school due to the complaints mentioned, and had very limited communication, including with his family.

There was no significant developmental delay in his history and he had no known chronic disease. The boy was living with an older brother who is fifteen years older than him, his mother and father. The patient's mother was followed with schizophrenia for 20 years and is currently in remission with risperidone 3 mg/day.

The patient, who was examined in detail in different centers and diagnosed with schizophrenia, was initially

started on risperidone treatment (4 mg/day) and used this treatment for four months. It was switched to aripiprazole because of unresponsiveness to treatment. Although aripiprazole 15 mg/day was used for three months, there was no significant improvement in psychotic symptoms. In our first evaluation, the PANSS score was 158, and the CGI-S score was 7. Since he did not benefit from aripiprazole, it was planned to switch to olanzapine treatment. Olanzapine was gradually increased to 20 mg/day and was used at this dose for 6 weeks. There was a partial response to olanzapine, with a PANSS score of 141 and a CGI-S score of 6. The case was evaluated by a committee of three experienced psychiatrists who confirmed the diagnosis of schizophrenia based DSM-5 and recommended switching to clozapine due to lack of adequate response to three different antipsychotics. Complete blood count, troponin, CRP tests and cardiology consultation (including Echo, ECG) were requested before clozapine treatment. Neurologic evaluation is not mandatory before starting clozapine, but we requested a detailed neurologic evaluation including MRI and EEG in our case due to the presence of VEOS; no problem was found here either. And the clozapine treatment was started gradually.

Weekly complete blood count and height-weight-blood pressure follow-ups were continued for 24 weeks. The dose of clozapine was increased up to 300 mg/day within six months. The patient's persecution and grandiosity delusions ceased, his disorganized behaviors decreased significantly, his interpersonal communication increased, his self-talk decreased, and his negativism and agitation ended. All blood counts were within normal range at the start of clozapine, during the follow-up period and at the end of six months. The patient who lost weight during the disease process was 142 cm (75-90th pctl) and 38 kg (75-90th pctl) when clozapine treatment was started. In six months of clozapine treatment, he was 147 cm (90-97th pctl) and 48 kg (97th pctl). Sedation, hypersalivation, headache were observed during clozapine therapy. Hypersalivation was evident after the dose was increased above 200 mg/day. Tropicamide drops were used for hypersalivation, and paracetamol was used for headaches. After clozapine therapy PANSS score was 87, and the CGI-S score was 3. There was a significant improvement in the patient's daily functionality. The patient was now able to attend school on a full-time basis. It was planned to follow up the case with clozapine 300 mg/day treatment once a month.

(The parents gave written consent for the publication of this report and the patient provided assent.)

## Discussion

In this paper, a successfully management with clozapine therapy of a case 10-year-old with VEOS was presented. In the literature review, few studies could be found on managing very early-onset schizophrenia cases. It seems that these cases are difficult to diagnose and to access effective treatment. In addition to medication, multidimensional support is needed.<sup>14</sup> We came across very few reports on the long-term use and follow-up of clozapine in these cases.<sup>15</sup> These cases are sometimes managed with alternative

combined pharmacotherapies.<sup>16</sup> Bailly et al. started clozapine after using two different antipsychotics in a 10-year-old case of VEOS, and no adverse effects were observed.<sup>17</sup> Mozes et al. used clozapine in four patients with VEOS. They encountered hypersalivation, subclinical EEG changes, mild tardive dyskinesia, stereotypical movement seizures, and enuresis nocturna during clozapine use.<sup>18</sup> In another study of patients using clozapine, it was reported that sedation and hypersalivation were the most common complaints reported by more than 90% of patients.<sup>15</sup> Other common adverse reactions (reported in 10-60% of patients) were enuresis, constipation, weight gain, and nonspecific EEG changes; it has been learned that neutropenia is reported in 6-15% of cases but is usually transient, and agranulocytosis is rare (<0.1%).<sup>15</sup>

Schizophrenia is an important disease in which genetic factors play a role in its etiology.<sup>19</sup> As expected, schizophrenia was found to be strongly associated with schizophrenia and related disorders in first-degree relatives.<sup>19</sup> The patient's mother was also receiving treatment with a diagnosis of schizophrenia. To the best of the researchers' knowledge, the relationship between genetic factors and onset of schizophrenia has been little investigated. Further studies on this subject are needed.

Clozapine was found to be superior for positive and negative symptoms treating schizophrenia.<sup>11</sup> Considering the possible side effects of clozapine, it has never been the agent of first choice in EOS.<sup>2</sup> Since schizophrenia started at a very early age in this patient, neurocognitive deterioration was rapid and severe, and the symptoms didn't improve with three previously used antipsychotics, so we switched to clozapine. There were no serious adverse events after clozapine treatment, and the patient's psychotic symptoms significantly improved. VEOS is more severe, and resistance to treatment is commonly seen. But very few cases have been found in the literature regarding the use of clozapine in those patients.<sup>20</sup> In conclusion clinicians would be well advised to keep clozapine in mind as a treatment option in cases of treatment-resistant VEOS. When there is an indication to switch to clozapine treatment, it would be in the best interest of these children and adolescents to start this treatment without delay.<sup>21</sup> However, further research is needed to investigate the consequences of long-term clozapine use in these cases.

## References

- Andreasen NC. Schizophrenia: The fundamental questions. *Brain Res Brain Res Rev.* 2000;31(2-3):106-112.
- McClellan J, Stock S. Practice parameter for the assessment and treatment of children and adolescents with schizophrenia. *J Am Acad Child Adolesc Psychiatry.* 2013;52(9):976-990.
- Röpcke B, Eggers C. Early-onset schizophrenia: A 15-year follow-up. *Eur Child Adolesc Psychiatry.* 2005;14(6):341-350.
- Thompson PM, Vidal C, Giedd JN, Gochman P, Blumenthal J, Nicolson R, Toga AW, Rapoport JL. Mapping adolescent brain change reveals dynamic wave of accelerated gray matter loss in very early-onset schizophrenia. *Proc Natl Acad Sci U S A.* 2001;98(20):11650-11655.
- Malla AK, Bodnar M, Joober R, Lepage M. Duration of untreated psychosis is associated with orbital-frontal grey matter volume reductions in first episode psychosis. *Schizophr Res.* 2011;125(1):13-20.
- Di Luzzio M, Pontillo M, Villa M, Attardi AG, Bellantoni D, Di Vincenzo C, Vicari S. Clinical features and comorbidity in very early-onset schizophrenia: a systematic review. *Front Psychiatry.* 2023;14:1270799.
- Pagsberg AK, Tarp S, Glinborg D, Stenstrøm AD, Fink-Jensen A, Correll CU, Christensen R. Acute antipsychotic treatment of children and adolescents with schizophrenia-spectrum disorders: a systematic review and network meta-analysis. *J Am Acad Child Adolesc Psychiatry.* 2017;56(3):191-202.
- Sadock BJ, Sadock VA, Kaplan HI. Kaplan & Sadock's comprehensive textbook of psychiatry. Philadelphia: Lippincott Williams & Wilkins, 2005.
- Wimberley T, Støvring H, Sørensen, HJ, Horsdal HT, MacCabe JH, Gasse C. Predictors of treatment resistance in patients with schizophrenia: a population-based cohort study. *The Lancet Psychiatry.* 2016;3(4):358-366.
- Meltzer, HY. Treatment-resistant schizophrenia - The role of clozapine. *Curr Med Res Opin.* 1997;14(1):1-20.
- Siskind D, McCartney L, Goldschlager, R, Kisely S. Clozapine v. first- and second-generation antipsychotics in treatment-refractory schizophrenia: systematic review and meta-analysis. *Br J Psychiatry.* 2016;209(5):385-392.
- Rachamalla V, Elberson BW, Vutam E, Aligeti M. Off-Label Use of Clozapine in Children and Adolescents—A Literature Review. *Am J of Ther.* 2019; 26(3):406-416.
- Pimenta de Figueiredo T, de Almeida IR, de Freitas FAC, Kubrusly CHC, Alvim-Soares Júnior AM, de Miranda DM. Beyond the off-label: a systematic review of what we know about clozapine use for children. *J Child Adolesc Psychopharmacol.* 2024;34(9):e419-e426.
- Aneja J, Singhai K, Paul K. Very early-onset psychosis/schizophrenia: case studies of spectrum of presentation and management issues. *J Family Med Prim Care.* 2018;7(6):1566-1570.
- Schneider C, Corrigall R, Hayes D, Kyriakopoulos M, Frangou S. Systematic review of the efficacy and tolerability of clozapine in the treatment of youth with early onset schizophrenia. *Eur Psychiatry.* 2014;29(1):1-10.
- Karal BN, Özdemir YE, Karayağmurlu A. The Management of Very Early-Onset Schizophrenia With an Olanzapine and Amisulpride Combination. *J Clin Psychopharmacol.* 2022;10-1097.
- Bailly D, De Chouly De Lenclave, MB. A rare and not very studied disorder: childhood-onset schizophrenia. A case report. *Encephale.* 2004;30(6):540-547.
- Mozes T, Toren P, Chernauzan N, Mester R, Yoran-Hegesh R, Blumensohn R, Weizman A. Clozapine treatment in very early onset schizophrenia. *J Am Acad Child Adolesc Psychiatry.* 1995;33(1):65-70.
- Mortensen PB, Pedersen MG, Pedersen CB. Psychiatric family history and schizophrenia risk in Denmark: Which mental disorders are relevant? *Psychol Med.* 2010;40(2):201-210.
- Williams R, Malla A, Roy MA, Joober R, Manchanda R, Tibbo P, Banks N, Agid O. What Is the Place of Clozapine in the Treatment of Early Psychosis in Canada? *n.* 2017;62(2):109-114.
- Trinczek E, Heinzel-Gutenbrunner M, Haberhausen M, Bachmann CJ. Time to initiation of clozapine treatment in children and adolescents with early-onset schizophrenia. *Pharmacopsychiatry.* 2016;49(06):254-259.





## Tailored Treatments: Utilizing Anti-TNFs for Ankylosing Spondylitis and Essential Thrombocytosis

Dilara Bulut Gökten<sup>1,a,\*</sup>, Ridvan Mercan<sup>1,b</sup>

<sup>1</sup> Department of Rheumatology, Tekirdag Namik Kemal University, Tekirdag, Turkiye

\*Corresponding author

### Case Report

#### History

Received: 03/01/2025

Accepted: 04/03/2025

#### Copyright



This work is licensed under  
Creative Commons Attribution 4.0  
International License

### ABSTRACT

Thrombocytosis is a condition that is often detected incidentally and can be seen both in the course of myeloproliferative diseases (MPD) and as a reactive condition. Ankylosing spondylitis (AS) is a chronic multisystemic inflammatory disease that mainly affects the spine. Mild to moderate thrombocytosis may occur secondary to the course of AS. In the treatment of AS, tumor necrosis factor inhibitor (anti-TNF) treatments are actively used as first-line therapy. The number of cases of MPDs occurring in the course of AS reported in the literature is limited. Although the exact effect of anti-TNF treatment on the MPD process is not fully known, there are publications stating that caution should be exercised in cases of MPD. By this case, we wanted to share our experience of using anti-TNF therapy in a patient diagnosed with ET in the course of AS. The 35-year-old male patient had been diagnosed with AS for 11 years and had been followed up by hematology with the diagnosis of essential thrombocytosis (ET) since 2010. When there was no response to indomethacin and sulfasalazine treatments, the patient was first given etanercept, and after secondary unresponsiveness, infliximab and adalimumab treatments were given. Despite the use of multiple anti-TNFs, no hematological deterioration was detected in terms of ET. Clinical and laboratory responses were also obtained in terms of AS. The patient has been stable and in remission in terms of both AS and ET since 2016.

**Keywords:** anti TNF, ankylosing spondylitis, essential thrombocytosis, tumor necrosis factor

## Kişiyeye Özel Tedaviler: Ankilozan Spondilit Ve Esansiyel Trombositozda Anti-TNF'lerin Kullanımı

### Olgu Sunumu

#### Süreç

Geliş: 03/01/2025

Kabul: 04/03/2025

#### Telif Hakkı



Bu Çalışma Creative Commons Atıf  
4.0 Uluslararası Lisansı  
Kapsamında Lisanslanmıştır.

### ÖZET

Trombositoz sıklıkla tesadüfen tespit edilen ve hem miyeloproliferatif hastalıkların (MPH) seyrinde hem de reaktif bir durum olarak görülebilen bir durumdur. Ankilozan spondilit (AS), esas olarak omurgayı etkileyen kronik, multisistemik inflamatuvar bir hastalıktır. AS'nin seyrine sekonder olarak hafif ila orta şiddette trombositoz meydana gelebilir. AS tedavisinde tümör nekroz faktör inhibitörü (anti-TNF) tedavileri birinci basamak tedavide aktif olarak kullanılmaktadır. Literatürde AS seyrinde ortaya çıkan MPH vakalarının sayısı sınırlıdır. Anti-TNF tedavisinin MPH sürecine etkisi tam olarak bilinmemekle birlikte bu vakalarda dikkatli olunması gerektiğini belirten yayınlar bulunmaktadır. Bu olguyla AS seyrinde ET tanısı alan bir hastada anti-TNF tedavisi kullanma deneyimimizi paylaşmak istedik. 35 yaşındaki erkek hastada 11 yıldır AS tanısı mevcuttu, 2010'dan beridir ise esansiyel trombositoz (ET) tanısı ile hematoloji tarafından takipliydi. Indometazin ve sulfasalazin tedavilerine yanıt alınamayınca hastaya önce etanercept, sekonder yanıtızsızlık üzerine de infliximab ve adalimumab tedavileri verildi. Çoklu anti-TNF kullanımına rağmen ET açısından herhangi bir hematolojik bozulma saptanmadı. AS açısından da klinik ve laboratuvar yanıtı alındı. Hasta 2016 yılından bu yana hem AS hem de ET açısından stabil ve remisyonunda izlenmektedir.

**Anahtar Kelimeler:** anti TNF, ankilozan spondilit, esansiyel trombositoz, tümör nekroz faktörü

<sup>a</sup> dilarabulutgokten@gmail.com

<sup>ID</sup> 0000-0002-9226-7532

<sup>b</sup> rmercan@nku.edu.tr

<sup>ID</sup> 0000-0003-1537-2192

**How to Cite:** Bulut Gökten D, Mercan R. Tailored Treatments: Utilizing Anti-TNFs for Ankylosing Spondylitis and Essential Thrombocytosis, Cumhuriyet Medical Journal, 2025;47(1):52-54

## Introduction

Thrombocytosis is a condition that is often detected incidentally and can be seen both in the course of myeloproliferative diseases (MPDs) and as a reactive condition. When seen as reactive, it is present in a secondary disease course and regresses with the treatment of the underlying condition. However, in clonal cases, it is associated with thrombotic events and bleeding. In such instances, cytoreductive treatments may be required(1).

Ankylosing spondylitis (AS) is a chronic multisystemic inflammatory disease that mainly affects the spine but may also involve peripheral joints. Mild to moderate thrombocytosis may occur secondary to the course of AS(2). Essential thrombocytosis (ET) is a MPD characterized by a prominent Janus kinase 2 (JAK2) mutation. ET should be suspected if the platelet count is consistently  $\geq 450.10^9/L$  in asymptomatic individuals(3).

In the treatment of AS, tumor necrosis factor inhibitor (anti-TNF) treatments are actively used as first-line therapy after non-steroidal anti-inflammatory drugs (NSAIDs). The number of cases of MPDs occurring in the course of AS reported in the literature is limited. Although the exact effect of anti-TNF treatment on the MPD process is not fully known, there are publications stating that caution should be exercised in cases of MPD(4).

By this case, we wanted to share our experience of using anti-TNF therapy in a patient diagnosed with JAK2-positive ET in the course of AS.

## Case

A 35-year-old male patient has had intermittent platelet values of  $\geq 800.10^9/L$  since 2010. He was monitored with aspirin for thrombocytosis in the hematology outpatient clinic and presented to our rheumatology outpatient clinic in 2013 with low back and hip pain that had been ongoing for seven years. Sacroiliac MRI was planned for the patient, and the MRI result was found to be compatible with bilateral sacroiliitis (see figure 1). The Bath Ankylosing Spondylitis Disease Activity Index (BASDAI) at the time of presentation was 6.5. The patient, who was also HLA-B27 positive, was diagnosed with AS based on the European Spondyloarthritis Study Group criteria(5). At his presentation in 2013, the patient's C-reactive protein (CRP) value was 32 mg/L and the erythrocyte sedimentation rate (ESR) was 46 mm/h. Previously, the patient had been treated with indomethacin and sulfasalazine. In 2014, etanercept treatment was initiated for the patient, who had no laboratory or clinical response during follow-up. Initially, a significant response was obtained with etanercept.

During follow-up, the patient's platelet levels remained persistently high, around  $700.10^9/L$ , and he was referred back to the hematology outpatient clinic. Bone marrow aspiration and biopsy were planned for the patient by hematology. As a result of aspiration and biopsy performed in 2015, an increase in the myeloid

series and megakaryocytes, a decrease in the erythroid series, and dysplasia findings were detected. The pathology was reported as compatible with ET. The JAK2V617F mutation was detected as positive in the patient, while the breakpoint cluster region–Abelson (BCR/ABL) rearrangement was negative, and cytogenetic analyses were reported as normal. Since he was also using anti-TNF therapy, he was frequently and jointly monitored by hematology and rheumatology. Hematology evaluated him as having a high risk of thrombosis and bleeding, and hydroxyurea was added to his aspirin treatment.

During AS follow-up, the patient developed uveitis twice while on etanercept, so he was switched to infliximab in 2015. After developing arthritis following nine months of infliximab treatment, he was considered secondarily unresponsive to treatment and was switched to adalimumab in 2016. Since 2016, the patient has been monitored as stable and in remission in terms of both AS and ET, with platelet values around  $400.10^9/L$ .

## Discussion

Since platelets are acute phase reactants, we expect a moderate increase in all systemic inflammatory events. However, even in systemic inflammatory diseases, when platelet counts are persistently high, especially at values  $>1,000.10^9/L$ , further investigation is required. The JAK2V617F mutation is actively used for diagnosis in these cases(6). Although our patient was diagnosed with ET due to the JAK2 mutation, it was not possible to exclude partial reactive thrombocytosis, which can accompany ET and be seen in the course of AS.

Aspirin is the first-line agent used in the treatment of thrombocytosis in the clinic. In cases where platelet counts remain high despite anti-platelet therapy and the estimated risk of thrombosis is high, agents such as hydroxyurea are added in clinical practice(7, 8). In our patient, the presence of an accompanying mutation and the chronic inflammatory condition seen in AS would increase the risk of arterial and venous thrombosis. Therefore, hydroxyurea was initiated by the hematologist in addition to aspirin. There were no side effects from hydroxyurea, and we observed a positive response to the treatment.

AS treatment is tailored to the patient's manifestations, taking into account the existing symptoms, general clinical condition, and prognostic markers. Initially, NSAIDs, which aim to alter the course of the disease, are used. This is followed by disease-modifying anti-rheumatic drugs (DMARDs). In cases of unresponsiveness, anti-TNF treatments are administered. TNF antagonists are well tolerated by patients and have proven to be highly effective in the AS treatment process(9). In our patient, we observed a significant improvement in the disease course, laboratory parameters, and functional indices with TNF treatments after unresponsiveness to conventional DMARDs.

There are also publications in the literature indicating that anti-TNF treatment reduces the number of platelets.

It is thought that these treatments may cause thrombocytopenia due to their reduction of cytokines such as IL-1, IL-6, and IL-8, as well as their unexplained complex hematopoietic effects(10). Another theory on this subject is that TNF antagonists increase the formation of immune complexes, which then bind to the platelet wall and cause platelet destruction(11). In our case, TNF antagonists used in accordance with these theories may have had positive effects on the patient's thrombocytosis. However, caution should be exercised in the use of anti-TNFs in hematological diseases, as one of the possible effects associated with these drugs is the development of malignancies(12). On this subject, it has been reported in the literature that secondary ET and acute myeloid leukemia can develop in individuals using anti-TNF therapy for inflammatory bowel disease(4). However, in

our experience with this patient, we did not encounter any negative situations despite using TNF antagonists for many years.

## Conclusion

In conclusion, when clonal stem cell diseases such as ET are accompanied by rheumatological conditions like AS, caution is needed when considering anti-TNF treatments. In this case, remission of AS was achieved, along with positive progress in managing thrombocytosis.

**Patient consent:** Informed consent was obtained and signed from the patient regarding the use of patient health information.

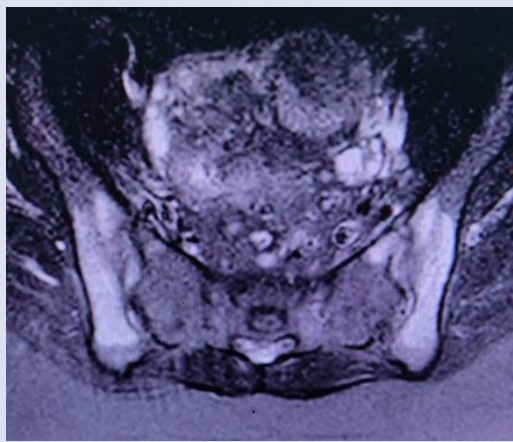

Figure 1: Magnetic resonance imaging showing bilateral sacroiliitis

## References

- Schafer AI. Thrombocytosis. *New England Journal of Medicine*. 2004;350(12):1211-9. DOI: 10.1056/NEJMra0353 63
- Deng L, Zheng P. Thrombocytosis in patients with spondyloarthritis: a case-control study. *BMC Musculoskeletal Disorders*. 2023;24(1):195. DOI: 10.1186/s12891-023-06304-1
- Tefferi A, Vannucchi AM, Barbui T. Essential thrombocythemia: 2024 update on diagnosis, risk stratification, and management. *Am J Hematol*. 2024;99(4):697-718. DOI: 10.1002/ajh.27216
- Fischer M, Helper DJ, Chiorean MV. Myeloproliferative disorders in patients with inflammatory bowel disease on anti-TNF- $\alpha$  therapy: Report of two cases and review of the literature. *Inflammatory Bowel Diseases*. 2010;17(2):674-5. DOI: 10.1002/ibd.21291
- Dougados M, van der Linden S, Juhlin R, Huitfeldt B, Amor B, Calin A, et al. The European Spondylarthropathy Study Group preliminary criteria for the classification of spondylarthropathy. *Arthritis Rheum*. 1991;34(10):1218-27. doi: 10.1002/art.1780341003.
- Ayvaz OC, Yavasoglu I, Kadikoylu G, Bozkurt G, Bolaman Z. Thrombocytosis in rheumatoid arthritis: JAK2V617F-positive essential thrombocythemia. *Rheumatol Int*. 2012;32(1):269-71. doi: 10.1007/s00296-010-1747-0.
- Barbui T, Barosi G, Grossi A, Gugliotta L, Liberato LN, Marchetti M, et al. Practice guidelines for the therapy of essential thrombocythemia. A statement from the Italian Society of Hematology, the Italian Society of Experimental Hematology and the Italian Group for Bone Marrow Transplantation. *Haematologica*. 2004;89(2):215-32. PMID: 15003898
- Di Minno MN, Iervolino S, Lupoli R, Russolillo A, Coppola A, Peluso R, et al. Cardiovascular risk in rheumatic patients: the link between inflammation and atherothrombosis. *Semin Thromb Hemost*. 2012;38(5):497-505. doi: 10.1055/s-0032-1306433.
- Khanna D, McMahon M, Furst DE. Safety of tumour necrosis factor-alpha antagonists. *Drug Saf*. 2004;27(5):307-24. doi: 10.2165/00002018-200427050-00003.
- Önmez A, Altun G, Akbaş T, Öneç B. Etanercept-Induced Thrombocytopenia In A Patient With Ankylosing Spondylitis. *DAHUDER Medical Journal*. 2022;2(1):28-9.
- Epistola R, Do T, Vankina R, Wu D, Yeh J, Fleischman MW, Lee JM. Immune Thrombocytopenic Purpura (ITP) as an Uncommon Extraintestinal Complication of Crohn's Disease: Case Vignette and Systematic Literature Review. *Case Rep Hematol*. 2020;2020:4785759. doi: 10.1155/2020/4785759
- Braun J, Sieper J. Therapy of ankylosing spondylitis and other spondyloarthritis: established medical treatment, anti-TNF- $\alpha$  therapy and other novel approaches. *Arthritis Research & Therapy*. 2002;4(5):307. doi: 10.1186/ar592



## Two Cases of Dermatomyositis with Anti-cN1A Antibody Positivity

Kubilay Tay<sup>1,a</sup>, Zeynep Toker Dinçer<sup>2,b</sup>, Kerem Parlar<sup>3,c</sup>, Gökçen Ünverengil<sup>4,d</sup>, Serdal Uğurlu<sup>2,e,\*</sup>

<sup>1</sup>Department of Internal Medicine, Cerrahpasa Medical Faculty, Istanbul University-Cerrahpasa, Istanbul, Türkiye.

<sup>2</sup>Division of Rheumatology, Department of Internal Medicine, Cerrahpasa Medical Faculty, Istanbul University-Cerrahpasa, Istanbul, Türkiye.

<sup>3</sup>Cerrahpasa University Faculty of Medicine, Istanbul, Türkiye.

<sup>4</sup>Department of Pathology, Istanbul Faculty of Medicine, Istanbul University, Istanbul, Türkiye.

\*Corresponding author

### Case Report

#### History

Received: 26/10/2024

Accepted: 08/03/2025

#### Copyright



This work is licensed under  
Creative Commons Attribution 4.0  
International License

### ABSTRACT

Idiopathic inflammatory myopathies (IIMs) are a heterogeneous group of autoimmune-mediated disorders. One of the most important developments in recent years regarding IIMs is the clinical use of myositis-specific antibodies and myositis-associated antibodies. The identification of anti-cytosolic 5'-nucleotidase 1A (anti-cN1A), one of the myositis-associated antibodies, represents significant progress in understanding inclusion body myositis (IBM), with research focusing on its role in predicting survival, diagnostic potential, clinical phenotype, and histopathological correlations. With the increasing use of autoantibodies in recent years, it is essential to understand their specificity and sensitivity properties. We presented two cases of dermatomyositis with positive anti-cN1A antibodies, which are known to have high specificity in IBM. One of the cases is a male patient, and IBM was included in the differential diagnosis because of anti-cN1A antibody positivity and resistance to first-line immunosuppressive therapy. The other case is a female patient diagnosed with dermatomyositis twelve years ago, with a myositis antibodies panel performed during a disease flare revealing anti-cN1A antibody positivity.

**Keywords:** inclusion body myositis; dermatomyositis; myositis specific autoantibodies; myositis associated antibodies; anti-cN1A antibodies

## Anti-cN1A Antikoru Pozitifliği Olan İki Dermatomyozit Vakası

### Olgu Sunumu

#### Süreç

Geliş: 26/10/2024

Kabul: 08/03/2025

#### Telif Hakkı



Bu Çalışma Creative Commons Atıf  
4.0 Uluslararası Lisansı  
Kapsamında Lisanslanmıştır.

### ÖZET

İdiyopatik İnflamatuvar Miyopatiler (İİM), otoimmün aracıli heterojen bir grup hastalıktır. İİM'ler ile ilgili son yıllarda en önemli gelişmelerden biri, miyozit spesifik antikolar ve miyozit ilişkili antikoların klinik kullanımınıdır. Miyozit ile ilişkili antikordardan biri olan anti-sitozolik 5'-nükleotidaz 1A (anti-cN1A)'nın tanımlanması ile inklüzyon cisimcikli miyozitin anlaşılmasında önemli bir ilerleme kaydedilmiştir ve bu alanda yapılan araştırmalar, bu antikorumun prognoz, tanıdaki kullanımı, klinik fenotip ve histopatolojik korelasyonları öngörmedeki rolüne odaklanmaktadır. Son yıllarda otoantikorumların artan kullanımı nedeniyle, bu antikorumların spesifitesine ve sensitivite özelliklerinin anlaşılması önemlidir. Bu çalışmada inklüzyon cisimcikli miyozite spesifitesine yüksek olduğu bilinen anti-cN1A antikorumunun pozitif saptandığı iki dermato Miyozit vakası sunuldu. Birinci vaka anti-cN1A antikoru pozitifliği olan ve başlangıç immünyüpresif tedaviye direnç göstermesi nedeniyle inklüzyon cisimcikli miyozitin ayırıcı tanıya alındığı erkek hastadır. İkinci vaka ise on iki yıl önce dermato Miyozit tanısı almış ve hastalık alevlenmesi sırasında bakılan miyozit antikorumları panelinde anti-cN1A antikoru pozitifliği saptanmış kadın hastadır.

**Anahtar Kelimeler:** inklüzyon cisimcikli miyozit; dermato Miyozit; miyozit spesifik antikolar; miyozit ilişkili antikolar; anti-cN1A antikorumları

<sup>a</sup> kubilaytay@hotmail.com

<sup>c</sup> keremparlar1@hotmail.com

<sup>e</sup> serdalugurlu@gmail.com

<sup>0</sup> 0009-0006-9061-6416

<sup>0</sup> 0000-0002-4919-4710

<sup>0</sup> 0000-0002-9561-2282

<sup>b</sup> tokerzeynep@hotmail.com

<sup>d</sup> gokcen.gundogdu@istanbul.edu.tr

<sup>0</sup> 0000-0002-0762-7725

<sup>0</sup> 0000-0003-3177-7851

**How to Cite:** Tay K, Toker Dinçer Z, Parlar K, Ünverengil G, Uğurlu S. Two Cases of Dermatomyositis with Anti-cN1A Antibody Positivity, Cumhuriyet Medical Journal,2025;46(1): 55-58

## Introduction

Idiopathic inflammatory myopathies (IIMs) are a heterogeneous group of autoimmune-mediated disorders characterized by chronic muscle inflammation and extramuscular involvement affecting the skin, pulmonary, cardiovascular, and gastrointestinal systems. Dermatomyositis, polymyositis, inclusion body myositis (IBM), anti-synthetase syndrome, immune-mediated necrotizing myopathy, and overlap myositis are classified within this group.<sup>1</sup> These conditions are distinguished from each other through clinical features, laboratory findings, pathology, electromyography (EMG), and imaging methods.<sup>1,2</sup>

One of the most important developments in recent years regarding IIMs is the clinical use of myositis-specific antibodies and myositis-associated antibodies. These autoantibodies are helpful in recognizing the clinical phenotype, predicting organ involvement, and determining prognosis.<sup>3</sup> The identification of anti-cytosolic 5'-nucleotidase 1A (anti-cN1A), one of the myositis-associated antibodies, represents significant progress in understanding IBM, with research focusing on its role in predicting survival, diagnostic potential, clinical phenotype, and histopathological correlations.<sup>4,5</sup>

With the increasing use of autoantibodies in recent years, it is essential to understand their specificity and sensitivity properties. Studies have shown that anti-cN1A antibodies can also be detected in other autoimmune diseases, such as primary Sjögren's syndrome and systemic lupus erythematosus (SLE). On the other hand, anti-cN1A antibody positivity is significantly lower in other IIMs compared to IBM, suggesting its potential role in distinguishing IBM from conditions like dermatomyositis.<sup>5</sup>

Here, we report two cases of dermatomyositis with anti-cN1A antibody positivity, questioning its specificity for IBM. One of the cases is a male patient, and IBM was included in the differential diagnosis because of anti-cN1A antibody positivity and resistance to first-line immunosuppressive therapy. The other case is a female patient diagnosed with dermatomyositis twelve years ago, with a myositis antibodies panel performed during a disease flare revealing anti-cN1A antibody positivity.

## Case 1

A 37-year-old male visited our clinic presenting with a rash on his face (Figure-1), nodular lesions on the scalp, and hard nodular lesions on the abdominal surface as well as the medial aspect of the right thigh. The patient reported no accompanying symptoms. Initial tests revealed positive Antinuclear Antibody (ANA) at a titer of 1/160 with a speckled pattern and negative anti-double stranded DNA (anti-dsDNA). Skin biopsies were compatible with the tumid form of lupus erythematosus.

The patient was preliminarily diagnosed with cutaneous lupus erythematosus and treated with azathioprine, hydroxychloroquine, and steroids. However, there was no improvement in skin symptoms after six months of

treatment. Due to the development of oropharyngeal dysphagia, proximal muscle weakness in the upper and lower extremities, and a weight loss of 10 kg in the last month, the patient was re-evaluated. Physical examination revealed 3/5 bilateral upper extremity proximal muscle strength, 4/5 distal muscle strength, 4/5 bilateral lower extremity proximal muscle strength, and 5/5 distal muscle strength. The patient had hyperemic skin lesions on the face, forehead, cheeks, and around the eyes. Laboratory investigations showed elevated levels of aspartate aminotransferase (AST) 62 IU/L, creatine kinase (CK) 588 U/L, lactate dehydrogenase (LDH) 407 U/L, C-reactive protein (CRP) 29 mg/L. The erythrocyte sedimentation rate (ESR) and alanine aminotransferase (ALT) were within normal levels.

Due to oropharyngeal dysphagia with a risk of aspiration pneumonia and significant weight loss, the patient was urgently started on 1-gram intravenous methylprednisolone for three days, followed by maintenance treatment with 60 mg/day of oral prednisolone and 2 g/day of mycophenolate mofetil (MMF). A needle EMG revealed significant myogenic involvement, especially in the proximal muscles, and the patient was initially diagnosed with IIMs. A barium swallow study was conducted due to dysphagia, which revealed tracheal aspiration in the form of overflow from the hypopharynx. A Positron Emission Tomography - Computed Tomography (PET/CT) scan was conducted for malignancy screening and to visualize muscle involvement, which revealed mild fluorodeoxyglucose (FDG) uptake in the muscle tissue. Prostate examination, gastroscopy, colonoscopy, thyroid ultrasound, scrotal ultrasound, and PET/CT did not reveal any malignancy.

The myositis-specific and myositis-associated antibodies panel was analyzed using the immunoblot technique from serum samples. The panel showed anti-SSA: 3+ and anti-cN1A antibody: 1+. Other autoantibodies were negative. Due to the positive detection of the anti-cN1A antibody and the dominant clinical manifestation of oropharyngeal dysphagia, IBM was included in the differential diagnosis. A biopsy taken from the deltoid muscle showed perifascicular atrophy and fibrosis, without inclusion bodies, which were consistent with the histomorphological findings of dermatomyositis (Figure-2).

The case was reassessed with the potential diagnosis of dermatomyositis and the skin biopsies performed during the patient's initial presentation were reevaluated. All the histologic findings were also consistent with dermatomyositis. The patient was then diagnosed with dermatomyositis. Due to the lack of improvement in extremity muscle strength, persistent oropharyngeal dysphagia, and the anticipated poor prognosis observed during treatment with MMF and high-dose steroids, MMF was discontinued. The patient was started on cyclophosphamide, rituximab, and intravenous immunoglobulin (IVIG) therapy. Significant improvement was observed in symptoms of oropharyngeal dysphagia at the end of the first month under this therapy. Oral feeding was initiated, and weight gain was achieved. Bilateral muscle strength was 5/5 in the upper and lower extremities. Muscle enzymes returned to normal.



**Figure-1:** Rash on patient's face at presentation.

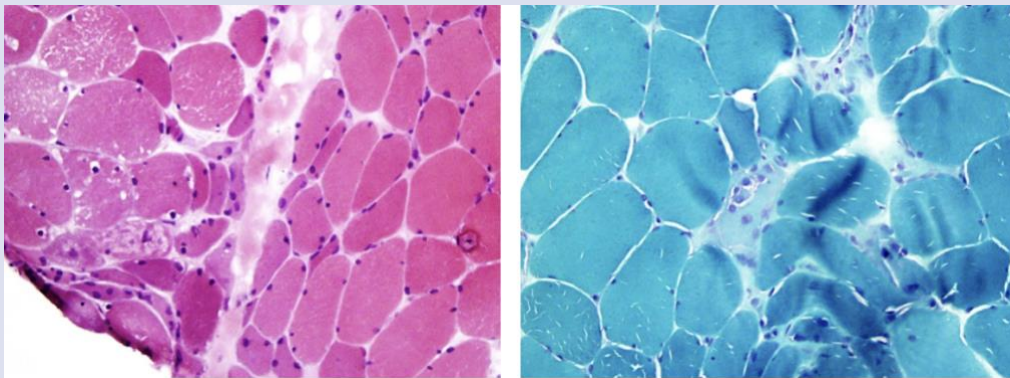

**Figure-2:** Histomorphological findings of muscle biopsy. A, Perifascicular atrophy (Hematoxylin-eosin staining x200). B, Necrotic muscle fibers (modified Gomori trichrome staining x200)

## Case 2

A 43-year-old female patient first presented to the internal medicine department twelve years ago with a rash on her face and edema in her eyes and feet. She also reported diffuse pain in her arms and shoulders and had difficulties raising her arms and climbing stairs. Laboratory tests showed elevated levels of CK (18000 U/L), LDH (1892 U/L), AST (960 IU/L), and ALT (560 IU/L). A needle EMG showed diffuse myogenic involvement. The anti-SSA and anti-histidyl-tRNA synthetase (anti-Jo-1) antibodies were positive. Muscle biopsy showed perifascicular atrophy and perimysial lymphoid infiltration, and she was diagnosed with dermatomyositis. She was treated with pulse glucocorticoids, followed by oral prednisolone, azathioprine 100 mg/day, and hydroxychloroquine 200 mg/day for the next five years until she had a flare similar to that she experienced when her disease first emerged. She was hospitalized again and treated with pulse glucocorticoids, MMF (2 g/day), and rituximab. Four years later, despite the treatment, the patient developed proximal muscle weakness and elevated CK levels. A new panel of myositis-specific and myositis-associated antibodies was examined in serum samples using the immunoblot method, which showed anti-SSA: 2+, anti-Jo-1: 3+, and anti-cN1A antibody: 3+. Although anti-cN1A antibody positivity was detected, the clinical presentation remained inconsistent with IBM. With a

diagnosis of dermatomyositis, the treatment was subsequently switched to IVIG and tofacitinib (10 mg/day). The patient remains in remission under this regimen.

## Discussion

Here, we present two cases of dermatomyositis with positive anti-cN1A antibodies, which are known to have a high specificity for IBM. The first case was initially diagnosed as cutaneous lupus erythematosus based on rash, skin biopsy results, and ANA positivity. During follow-up, with the development of oropharyngeal dysphagia, proximal muscle weakness, and elevated muscle enzyme levels, IIMs were considered in the diagnosis. After the myositis antibody panel was positive for both anti-cN1A and anti-SSA, along with distal muscle weakness (less severe than proximal weakness), oropharyngeal dysphagia, and resistance to first-line immunosuppressive treatment, IBM was included in the differential diagnosis. Based on the patient's age, symmetric proximal muscle weakness rather than distal weakness, and muscle biopsy findings inconsistent with IBM, we excluded the diagnosis of IBM, confirming the diagnosis of dermatomyositis. The second case involved a female patient with a history of dermatomyositis, in which anti-cN1A positivity was detected during a disease flare.

There were no findings suggestive of IBM based on the clinical findings and muscle biopsy results.

Idiopathic inflammatory myopathies are a group of diseases that commonly present with muscle weakness; however, the subgroups exhibit significant heterogeneity. The identification of myositis-specific and myositis-associated antibodies has shown that this heterogeneity is both clinical and serological. With the increasing use of these antibodies in clinical practice, it is essential to understand their characteristics.<sup>6</sup> These cases highlight dermatomyositis with anti-cN1A positivity, questioning its specificity for IBM.

Autoantibodies targeting cN1A, an enzyme involved in nucleic acid metabolism and expressed in skeletal muscle, are present in IBM patients.<sup>4,7</sup> IBM typically occurs in men over the age of 50 years, affects both proximal and distal muscle groups, often with asymmetric involvement, and may also involve the facial muscles. Dramatically elevated muscle enzyme levels were not observed, and dysphagia developed in > 50% of the patients. In terms of clinical findings and resistance to immunosuppressive therapy, IBM differs from other IIMs.<sup>1,2</sup> With the detection of anti-cN1A antibodies in IBM patients, it has been recognized that autoimmune mechanisms may also play a role in its pathogenesis in addition to degenerative mechanisms.<sup>4,7</sup>

Various techniques, such as Immunoblotting, Enzyme-Linked Immunosorbent Assay (ELISA), Cell-Based Immunofluorescence Cytochemistry, and Addressable Laser Bead Immunoassay (ALBIA) have been reported in the literature for the detection of anti-cN1A antibodies. Depending on the technical differences and variations in cutoff values, the sensitivity and specificity vary.<sup>5</sup> A meta-analysis including seven studies conducted between 1990 and 2020 compared anti-cN1A positivity between IBM and PM/DM, autoimmune diseases, and neuromuscular disorders. The evaluation of 599 IBM patients and 1,676 patients with other conditions revealed that the positive predictive value (PPV) of the tests was 0.25 in the general population and increased to 0.75 in individuals over 50 years of age, while the diagnostic significance remained insufficient.<sup>8</sup> In the assessment of this meta-analysis, variations in assay techniques, the lack of adjustments for factors such as age, gender, ethnicity, disease severity, comorbidities, and the limited number of studies should be considered.

In suspected cases of IIMs, an extended myositis panel is routinely used. This helps to confirm the diagnosis and provides insights into organ involvement and prognosis.

### Conclusion

Due to the relative rarity of IBM, more data is needed on anti-cN1A antibodies, and the information available is based on studies with small populations. More research needs to be done to demonstrate the relationship

between clinical presentation and anti-cN1A positivity in patients diagnosed with dermatomyositis. The role of antibodies in the diagnosis of rheumatologic diseases is increasing day by day, but clinical findings and biopsy remain the most important methods.

### Patient Consent

Written informed consent was obtained from the patients for publication of this case report.

### Acknowledgments

None

### Authorship Contribution

Design: S.U., Z.T.D.

Data Collection: K.T., K.P., G.U.

Manuscript Writing: K.T., K.P., Z.T.D.

Supervision: S.U

### Conflict of Interest

The authors declare no conflict of interest.

### References

- 1- Lundberg IE, Fujimoto M, Vencovsky J, et al. Idiopathic inflammatory myopathies. *Nat Rev Dis Primers*. 2021;7(1):86. Published 2021 Dec 2. doi:10.1038/s41572-021-00321-x
- 2- Allameen NA, Salam S, Reddy V, Machado PM. Inclusion body myositis and immunosenescence: current evidence and future perspectives. *Rheumatology (Oxford)*. Published online November 6, 2024. doi:10.1093/rheumatology/keae614
- 3- Allameen NA, Ramos-Lisbona AI, Wedderburn LR, Lundberg IE, Isenberg DA. An update on autoantibodies in the idiopathic inflammatory myopathies. *Nat Rev Rheumatol*. 2025;21(1):46-62. doi:10.1038/s41584-024-01188-4
- 4- Larman HB, Salajegheh M, Nazareno R, et al. Cytosolic 5'-nucleotidase 1A autoimmunity in sporadic inclusion body myositis. *Ann Neurol*. 2013;73(3):408-418. doi:10.1002/ana.23840
- 5- Salam S, Dimachkie MM, Hanna MG, Machado PM. Diagnostic and prognostic value of anti-cN1A antibodies in inclusion body myositis. *Clin Exp Rheumatol*. 2022;40(2):384-393. doi:10.55563/clinexprheumatol/r625rm
- 6- Lundberg IE, Fujimoto M, Vencovsky J, et al. Idiopathic inflammatory myopathies. *Nat Rev Dis Primers*. 2021;7(1):87. Published 2021 Dec 2. doi:10.1038/s41572-021-00325-7
- 7- Pluk H, van Hoeve BJ, van Dooren SH, et al. Autoantibodies to cytosolic 5'-nucleotidase 1A in inclusion body myositis. *Ann Neurol*. 2013;73(3):397-407. doi:10.1002/ana.23822
- 8- Mavroudis I, Knights M, Petridis F, Chatzikonstantinou S, Karantali E, Kazis D. Diagnostic Accuracy of Anti-CN1A on the Diagnosis of Inclusion Body Myositis. A Hierarchical Bivariate and Bayesian Meta-analysis. *J Clin Neuromuscul Dis*. 2021;23(1):31-38. doi:10.1097/CND.0000000000000353



## Surgical Treatment of Low-Grade Lumbar Spondylolisthesis

Hüseyin DOĞU<sup>1,a</sup>

<sup>1</sup>Department of Neurosurgery, Medicine Hospital, Atlas University, Istanbul, Türkiye

### Research Article

#### History

Received: 31/07/2023

Accepted: 26/09/2023

Correction: 28/03/2025

### ABSTRACT

Lumbar spondylolisthesis is a prevalent cause of lower back pain and is a focal interest of spinal surgery. A diverse set of decompression and fusion techniques are used in surgery.

To investigate the surgical and clinical outcomes patients with spondylolisthesis who received surgical intervention.

Data from 25 patients (15 women; 10 men; mean age, 48.8 ± 12.4 years; range, 27–66 years) with low-grade spondylolisthesis who received surgical intervention were retrospectively analyzed. Posterolateral and posterior interbody fusion was used in 17 and 8 patients, respectively, and 19 received posterior pedicle screws and 6 received only fusion and decompression.

According to the Kirkaldy–Willis criteria, the clinical outcomes of 11 (44%), 9 (36%), 3 (12%), and 2 (8%) patients were rated excellent, good, fair, and poor, respectively, with a success rate of 80%. Furthermore, fusion was observed in 21 patients (84%). Favorable outcomes were achieved in 17 (90%) patients with pedicle screws and in 3 (50%) with only decompression and fusion ( $p=0.048$ ;  $p<0.05$ ). The rate of favorable outcome was 75% of patients who smoked ( $p=0.226$ ;  $p>0.05$ ). Two out of three patients with revision surgery had poor clinical outcomes ( $p=0.091$ ;  $p<0.05$ ).

The addition of pedicle screw fixation to posterolateral fusion increases fusion rates and yields satisfactory clinical results. Previous history of surgery is a risk factor that should be considered before deciding to perform surgery. Furthermore, the transpedicular screw fixation technique can be made less complicated and effective via effective and experienced teamwork. Herein, we reviewed recent studies and discussed the indications, complications, and outcomes of surgical treatment of low-grade spondylolisthesis.

**Keywords:** Lumbar spondylolisthesis, pedicle screws, fusion

## Düşük Dereceli Lomber Spondilolistezisin Cerrahi Tedavisi

#### Süreç

Geliş: 31/07/2023

Kabul: 26/09/2023

Düzeltilme: 28/03/2025

### ÖZ

Lomber spondilolistezis bel ağrısının yaygın bir nedenidir ve omurga cerrahisinin odak noktasıdır. Cerrahide çok çeşitli dekompresyon ve füzyon teknikleri kullanılmaktadır.

Cerrahi girişim uygulanan spondilolistezisli hastaların cerrahi ve klinik sonuçlarını araştırmak.

Düşük dereceli spondilolistezis nedeniyle cerrahi girişim uygulanan 25 hastanın (15 kadın; 10 erkek; ortalama yaş, 48,8 ± 12,4 yıl; aralık, 27-66 yıl) verileri retrospektif olarak analiz edildi. Sırasıyla 17 ve 8 hastaya posterolateral ve posterior interbody füzyon uygulandı ve 19'una posterior pedikül vidası, 6'sına ise sadece füzyon ve dekompresyon uygulandı.

Kirkaldy-Willis kriterlerine göre 11 (%44), 9 (%36), 3 (%12) ve 2 (%8) hastanın klinik sonuçları mükemmel, iyi, orta ve kötü olarak derecelendirildi. sırasıyla %80 başarı oranıyla. Ayrıca 21 hastada (%84) füzyon gözlemlendi. Hastaların 17'sinde (%90) pedikül vidası, 3'ünde (%50) ise sadece dekompresyon ve füzyon ile olumlu sonuçlar elde edildi ( $p=0,048$ ;  $p<0,05$ ). Sigara içen hastalarda olumlu sonuç oranı %75 idi ( $p=0,226$ ;  $p>0,05$ ). Revizyon cerrahisi yapılan üç hastanın ikisinde kötü klinik sonuçlar elde edildi ( $p=0,091$ ;  $p<0,05$ ).

Posterolateral füzyona pedikül vidası fiksasyonunun eklenmesi füzyon oranlarını arttırmakta ve tatmin edici klinik sonuçlar vermektedir. Önceki ameliyat öyküsü, ameliyata karar vermeden önce dikkate alınması gereken bir risk faktörüdür. Ayrıca etkili ve deneyimli bir ekip çalışmasıyla transpediküler vida tespit tekniği daha az karmaşık ve etkili hale getirilebilir. Burada güncel çalışmalarını gözden geçirdik ve düşük dereceli spondilolistezisin cerrahi tedavisinin endikasyonlarını, komplikasyonlarını ve sonuçlarını tartıştık.

**Anahtar sözcükler:** Lomber spondilolistezis, pedikül vidaları, füzyon

#### License



This work is licensed under Creative Commons Attribution 4.0 International License

<sup>a</sup> [huseyindogu@gmail.com](mailto:huseyindogu@gmail.com)

<https://orcid.org/0000-0002-7754-4984>



## Introduction

Lumbar spondylolisthesis is an important cause of spinal canal stenosis and is often associated with back and leg pain, restriction in daily activities, and significant work disability. Various techniques intended for the surgical treatment of lumbar spondylolisthesis have been developed thus far, and the development of new techniques has continued.

<sup>1,2,3,4</sup> No golden standard for the surgical treatment of spondylolisthesis has been established thus far. Fusion is an indispensable part of spondylolisthesis treatment and other conditions of spinal instability. However, achieving adequate fusion and favorable clinical outcomes is not always possible in adults with spondylolisthesis. <sup>5</sup> The technique involving stabilization with the posterior pedicle screw has garnered increased use in recent years and was believed to provide a better solution. The disadvantages of this technique include that it is a major surgical procedure, has relatively high complications, and is an expensive surgical technique; thus, exercising precaution during patient selection is important. <sup>6,7</sup> The present study aimed to determine the patient group and the extent to which the patients would benefit from surgical treatment and review the problems associated with the treatment in light of the recent studies.

## Material and Method

This retrospective study included 25 patients who received surgical intervention for low-grade lumbar spondylolisthesis between September 1991 and January 1998 at the Neurosurgical Clinics of Şişli Etfal and Taksim Education and Research Hospitals. The article was derived from a dissertation study. Study data, including age, sex, preoperative complaints, physical examination, and radiologic findings, were recorded. Patients underwent follow-up examinations and radiologic tests for a mean period of 31 months (range from 6 months to 4 years) postoperatively. Kirkaldy–Willis criteria (excellent, good, fair, and poor) were used to assess the effectiveness of the surgical intervention. <sup>8</sup> The patients deemed eligible for surgery showed clinical and radiological findings compatible with spondylolisthesis, and these patients did not benefit from conservative treatment methods, including bed rest, medical treatment, and physical therapy and rehabilitation. The prerequisites for surgical indication were neurologic deficit, neurogenic claudication, spondylolisthesis, and postural abnormality, among others.

Dynamic lumbosacral radiography was used to radiologically confirm spondylolisthesis, a tensional movement of  $\geq 4$  mm, in the patients. The

techniques accommodated during the surgical interventions included fenestration, laminectomy, posterior lumbar interbody fusion (PLIF) with no cage, posterolateral fusion (PLF), and stabilization with posterior pedicle screw technique. A combination of these techniques was used based on the indication of the cases. Reduction was not used in any patient. Autologous graft, collected from the iliac wing bone, was used for fusion. Fusion was believed to have occurred upon observation of bilateral trabecular bone continuity between the fused segments.

## Statistical Analyses

The Number Cruncher Statistical System (NCSS) 2020 Statistical Software (NCSS LLC, Kaysville, Utah, USA) was used for statistical analysis. Fisher's Exact Test was used to compare qualitative data. Results were analyzed at a 95% confidence interval, and a  $p$  level of  $<0.05$  indicated statistical significance.

## Surgical Technique

Patients were placed in a prone position to expose the abdomen. Prophylactic antibiotherapy was administered, and surgery was commenced under general anesthesia after determining the vertebral level using fluoroscopy. A vertical incision was made into the midline to clearly view the surgical area. The paravertebral muscles were bilaterally, subperiosteally dissected, after which the laminae, facet joints, pars interarticularis, and transverse processes were exposed. Pedicle screw entry points at the instrumentation levels were set using the intersection technique. First, the entry point was prepared with a curette and then the screw path was prepared with a special pedicle curette, while accounting for the transverse and sagittal pedicle angles. Meanwhile, the screw path was intermittently controlled using Kirshner wires. When a transition from cortical bone to soft tissue was detected, another nearby point was selected to provide secure fixation. After determining the screws according to their respective levels, the screws were placed into the prepared pathways in an orientation as appropriate to their angles. Due care was taken to avoid trespassing the anterior cortex in terms of implantation depth. Necessary decompression was then performed. Bone graft from the iliac wing bone was shaped to fit the distance in cases of interbody fusion. The graft was placed in the disc space, allowing minimal neural manipulation. The posterior lumbar fusion (PLF) was placed in the form of lamellae on the facets and between the transverse processes. Screw–rod connection was ensured by shaping the rods to fit their physiologic curvatures. Hemostasis was achieved before closure.

**Results**

Among the 25 patients who received surgical intervention for lumbar spondylolisthesis, 10 were male (40%), 15 were female (60%), and the mean patient age was  $48.8 \pm 12.4$  years (range, 27–66 years). (Figure 1) Lower back pain was the leading complaint at a presentation by all the patients

included in the study. (Table 1) Pain radiating to the leg was unilateral in 14 patients and bilateral in 4. The mean duration of pain experienced by the patients was 4.8 years (range, 4 months to 11 years). Upon physical examination of the patients, the most prevalent finding was the positive straight leg raising test and sensory deficit (Table 2).

**Figure 1.** Distribution of cases based on age and gender.

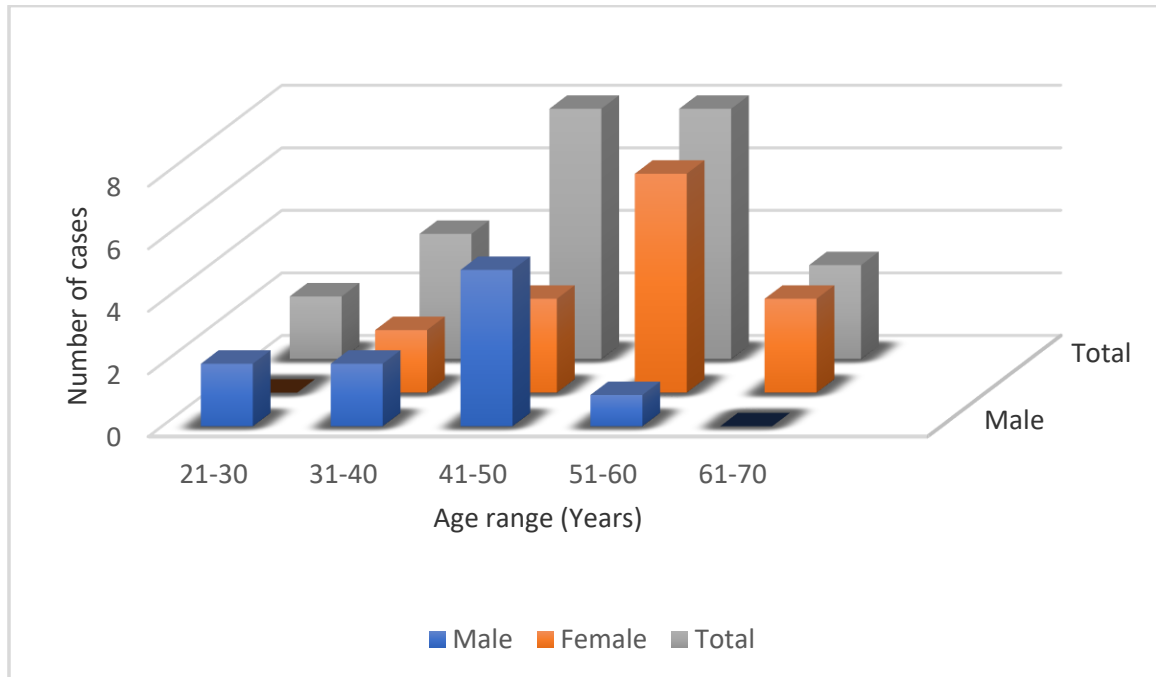

**Table 1.** Patients' complaints at admission

Symptoms	Number of cases (%)
<b>Lower back pain</b>	25 (100%)
<b>Pain radiating to the leg</b>	18 (72%)
<b>Muscle weakness</b>	5 (20%)
<b>Numbness in the foot</b>	4 (16%)

The mean slippage rate was 24% (range, 15%–51%) based on Tailard’s method.<sup>9</sup> Furthermore, isthmic, degenerative, and postoperative spondylolisthesis was observed in 11, 13, and 1 patients, respectively (Figure 2). The age of patients with degenerative spondylolisthesis was 41–60 years, whereas patients with isthmic spondylolisthesis were distributed across all age groups (Figure 3).

**Table 2.** Examination findings of the patients

FINDINGS	Case (%)
<b>Straight leg raise test</b>	18 (72%)
<b>Motor deficit</b>	11 (44%)
<b>Sensory deficit</b>	18 (72%)
<b>Reflex deficit</b>	12 (48%)
<b>Neurogenic claudication</b>	7 (28%)
<b>Atrophy</b>	5 (20%)

Spondylolisthesis was at the level of L5–S1 in 11 patients, L4–5 in 9, L3–4 in 4, and L2–3 in 1. Comorbid lumbar stenosis and lumbar disc herniation was observed in 9 and 7 patients with spondylolisthesis, respectively. Of the 19 patients who received stabilization with the posterior pedicle screw technique, 4 had six screws, and 15 had four screws. A total of 6 patients only underwent decompression and PLF, whereas 19 patients underwent fenestration and foraminotomy, with 6 patients receiving decompression with laminectomy. PLF was performed in 17 patients, and PLIF was performed in the remaining 8 patients. The mean duration of

hospitalization was 13.5 days, and the mean duration of surgery was 3.5 hours.

In total, 20 patients were rated as excellent or good and 5 as fair or poor based on the Kirkaldy–Willis Grading system. Good outcome was observed in 17 (90%) patients with pedicle screws and in 3 (50%) patients with only decompression and fusion. The difference was significant ( $p=0.048$ ;  $p<0.05$ ), with a higher rate of good outcome in the patients with pedicle screws. In patients who smoked, 75% of the patients showed good results. The patients who smoked showed no significant difference when compared with those who did not smoke ( $p=0.226$ ;  $p<0.05$ ).

The clinical outcome in patients without revision surgery was good in 19 patients (86.4%). A good outcome was achieved in only one of the 3 patients (33.3%) who received revision surgery. Although the difference was not significant, the p value was close to the level of significance. A significantly high rate of good outcomes was noted in patients who did not undergo revision surgery ( $p=0.091$ ;  $p<0.05$ ). Radiologic examination revealed the absence of an increase in the slippage percentage in these patients. Furthermore, fusion was observed in 21 patients (84%).

**Figure 2.** Distribution of the type of spondylolisthesis

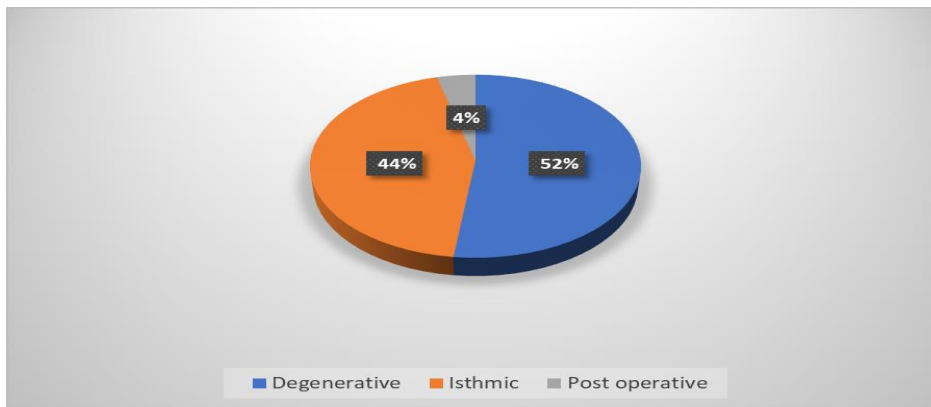

**Figure 3.** Age incidence of the most common types of spondylolisthesis

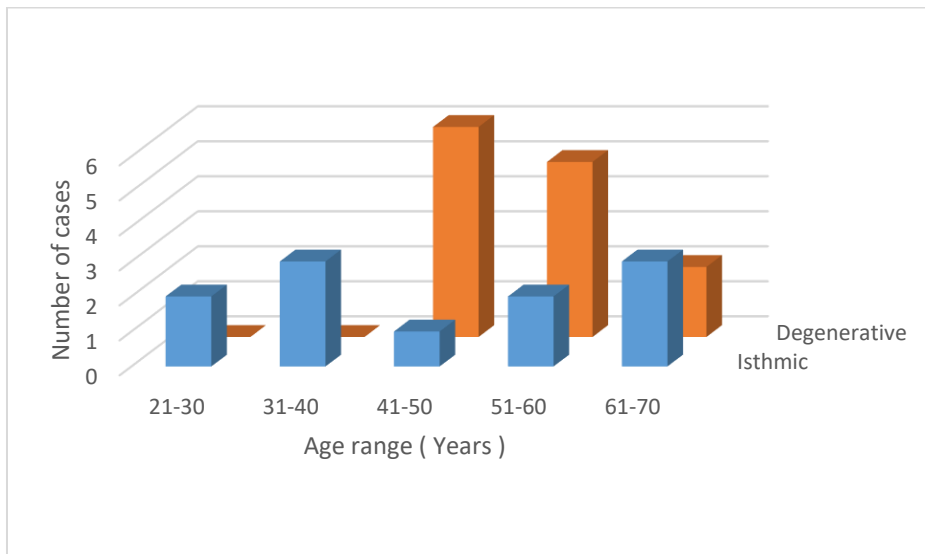

## Complications

Two patients with a superficial infection at the surgical site were treated via antibiotherapy and dressing. No surgical intervention was considered necessary. All patients, who received grafts from the iliac bone wing, experienced severe postoperative pain at the origin of the iliac bone area. Analgesics were used to treat pain, and these pains did not persist for a prolonged period. Major postoperative complications were observed in 5 patients. One patient experienced a cerebrospinal fluid (CSF) fistula, which was successfully managed with conservative treatment involving measures such as bed rest, maintaining an upright position, and avoiding activities that could raise intracranial pressure, including lifting and straining. Wound care was administered using dressings, and by the third day, the leakage had ceased. One patient had an abscess at the paravertebral muscles, which was treated by draining the abscess and administering antibiotherapy. In one patient, root compression occurred upon narrowing the foramen because the screw appeared to be misoriented; this was treated by repositioning the screw during revision surgery. The grafts in one patient with PLIF had slipped into the spinal canal, and pedicle screw penetration was visible via the lumbar computed tomography imaging performed for control purposes. The reoperated patient had bone grafts removed from the disc space and PLF and screw repositioning were performed. The patient's clinical condition did not improve after revision surgery, and therefore, the instruments were removed through reoperation. In another patient who had undergone PLIF, the grafts had slipped into the spinal canal, inducing increased pain. The patient was treated by repositioning the grafts and removing the compression, which resulted in successful decompression.

## Discussion

A golden standard for the principles of surgical treatment for low-grade spondylolisthesis has not been established thus far, and debate regarding decompression, fusion technique, instrumentation, and graft type is ongoing. Furthermore, different techniques have been used, which include microdecompression<sup>10</sup>, transvertebral screw fixation<sup>11</sup>, and defect repair with screws and hooks<sup>12</sup> and with screws and wiring<sup>13</sup>. Significant treatment progress could have been achieved through the introduction of spinal instrumentation in the treatment of spondylolisthesis. However, on the grounds that conventional treatment methods continue to be indispensable, fusion can only be achieved in combination with spinal instrumentation. The aim of surgical treatment in

the treatment of spondylolisthesis should be to prevent deficits, provide maximum improvement in existing deficits, relieve pain, ensure stability, stop the progression of slippage, and improve quality of life<sup>14</sup>.

Most patients with low-grade spondylolisthesis without neurologic deficit benefit from conservative treatment.<sup>15, 16</sup> Evan D Boyd et al. studied a group of 46 patients with grade 1 spondylolisthesis and spondylolysis and reported that favorable outcomes can be achieved through conservative treatment.<sup>17</sup> Nava-Bringas et al. achieved good outcomes in terms of pain and function in a study with exercise groups and reported no difference in clinical outcome between different exercise programs.<sup>18</sup> However, Matsunaga suggested that listhesis may increase up to 30% after conservative treatment.<sup>19</sup>

Although fusion is one of the main principles of treatment in spondylolisthesis, only decompression can achieve minimal intervention. A review of the clinical results in patients who underwent decompression without fusion revealed highly satisfactory results.<sup>20, 21, 22</sup> However, Jang JW et al. suggested that slippage increased in cases where decompression alone was performed.<sup>23</sup> Muslim et al. reported that bilateral microdecompression with unilateral intervention was associated with satisfactory results, and there was no increase in slippage.<sup>24</sup>

Reportedly, a clinically significant difference in quality of life was observed in patients with degenerative low-grade spondylolisthesis following the addition of lumbar spinal fusion to decompression.<sup>25, 26</sup> Takahiro Tsutsumimoto et al. achieved a 69% recovery rate after decompression and non-instrumented fusion.<sup>27</sup> Despite a 74% fusion in the above series, no significant difference was noted in terms of the clinical outcome between those with and without fusion. However, previous studies with fusion alone, reported a significant rate of pseudoarthrosis compared with instrumented fusion.<sup>28</sup> In their review article, Martin et al. reported that fusion had a favorable effect on the clinical outcome compared with the clinical outcomes of patients who underwent decompression alone. Accordingly, they reported that the use of instruments increased fusion rates but did not ensure significant superiority in terms of clinical outcome.

A study combined fusion and decompression and reported satisfactory outcomes through the use of instrumented fusion and interbody fusion at a rate of 77% and 79%, respectively, compared with 64%

satisfactory results with fusion alone.<sup>29</sup> Yong-ping Ye et al. suggested that instrumentation increased fusion rates but was not associated with satisfaction.<sup>30</sup> In the present study, all the patients received fusions with a success rate of 84%. The fusion rate was variable in adults, and obesity, osteoporosis, smoking, and systemic diseases may lead to lower-than-expected results.<sup>31</sup> Fusion rates were better in children than in adults. According to a study by Jalenko et al., 85% fusion was achieved in children who received non-instrumented intervention in isthmic spondylolisthesis, whereas the same rate was 65% in adults.<sup>32</sup>

PLIF can be performed in patients undergoing discectomy. In recent years, the application of PLIF technique has become increasingly popular. As observed in the present study, PLIF is performed with cages in the majority of cases despite the fact that PLIF was typically performed without cages in the past. However, anterior lumbar interbody fusion (ALIF) and PLIF alone were reported to be biomechanically inferior to instrumented fusion and were not considered a standard for spinal fusion.<sup>33</sup> Therefore, PLIF may be considered suitable for use in instrumented fusion surgeries. A number of previous studies have reported successful results using PLIF. In most of those studies, a higher rate of fusion was obtained through PLIF than via PLF.<sup>35,36</sup> However, the existence of a difference between the two methods in terms of clinical outcome remains unclear. In their review article, Okuda et al. reported that a mean of 82% satisfactory results were achieved in the PLIF series.<sup>37</sup> Liu et al. suggested that PLIF was associated with fewer complications and higher fusion rates than PLF.<sup>38</sup>

Instrumentation has been adopted by a wide range of authors on the grounds that it provides a rigid fixation and increases the likelihood of fusion. Fixation, when combined with decompression, reduces pain, stops deformity progression, and allows for early mobilization. The transpedicular screw system is the most preferred technique because pedicle screws provide biomechanically stronger three-column stabilization than other fixation options. Pedicle screws do not require an intact posterior element. Despite the risk of neural damage, CSF fistula, vascular damage, and increased risk of infection, pedicle screws have been proven to be safe in experienced hands.

Whether bone fusion correlates with clinical outcome remains a controversial issue. Certain authors reported that clinical outcomes correlated well with fusion rates.<sup>39</sup> However, Fritzell et al. suggested that radiologic fusion did not correlate significantly with clinical outcome.<sup>40</sup> Inamdor et al.

preferred PLF to PLIF due to the simplicity of the procedure, low rate of complications, and better clinical and radiologic results, although both groups reported a fusion rate of 100%.<sup>41</sup> Hallett et al. compared decompression alone, PLF + pedicle screw, and transforaminal lumbar interbody fusion (TLIF) + pedicle screw technique and reported that >90% fusion was achieved in the PLF group without significant intergroup difference in terms of functional results.<sup>42</sup> In the cases included in the present study, the clinical outcome was good or excellent in 90% of the patients, who underwent pedicle screws.

Fischgrund et al. investigated the effect of instrumentation in lumbar stenosis secondary to degenerative spondylolisthesis in a prospective randomized study. Sixty-seven patients received instrumented and non-instrumented decompression and fusion. After completing the follow-up, fusion rates of 82% and 48% were achieved in instrumented and non-instrumented cases, respectively.<sup>43</sup> Considering that there were reports on patients with spondylolisthesis, who received pedicle screw fixation without any success, despite an increased fusion rate, solid fusion was believed to not be the only factor that influenced clinical outcomes. Despite a fusion rate of 84% in the cases included in the present study, the good clinical outcome rate was 80%.

Fusion assessment was reported to be challenging in several studies, and identifying fusion using radiologic examinations is particularly difficult in all cases. Pseudoarthrosis may be painful as well as asymptomatic.<sup>44</sup> When patients who were radiologically considered to have fusion underwent re-operation for other etiologies, some patients appeared to not have fusion. Therefore, it can be suggested that "the best identification of fusion is by intraoperative inspection, albeit not practical."<sup>45</sup>

Smoking is an important risk factor associated with preventing return to pre-disease activity and pain relief. In studies with a number of fusion series, poor results and high pseudoarthrosis rate were reported among smokers.<sup>31,44</sup> However, studies in the past have also suggested that smoking had no effect on fusion.<sup>45</sup> Although the rate of clinically good outcome was lower (75%) in smokers in the present study, this rate was not significant.

The need for revision surgery was one of the most prominent factors affecting the outcome of lumbar decompression and fusion surgery.<sup>36</sup> A recent study reported a 13.5% re-operation rate in a database analysis of lumbar fusion surgery.<sup>46</sup> Patients who underwent repeated operations showed

remarkably poor outcomes, and even in cases of re-operation, the results were unsatisfactory.<sup>36</sup> Seung-Pyo Suh et al. reported a fusion rate of 71% in patients, who underwent revision surgery for pseudoarthrosis, with satisfactory results in only 52%.<sup>47</sup> Derman et al. reported in a review article that revision with PLF resulted in pseudoarthrosis in 35%–51% of cases. In addition, no significant difference was observed between different techniques, including TLIF, ALIF, and PLIF, in terms of patients' quality of life after PLF revision surgeries. Therefore, a study suggested that the surgical strategy of each revision case should be different.<sup>48</sup> In the series included in the present study, 3 cases underwent revision surgery and had a good clinical outcome rate of 33%. A major infection occurred in one patient (4%), consistent with the reported rate of 0.7%–11.9%.<sup>49</sup> Contrary to the previous studies, the instrument did not have to be removed as a result of the infection.

### Limitations

The primary limitation to the present study was the comparatively low number of cases. More optimized results could be achieved through future studies with a larger number of cases. Another limitation is that the factors that might have an effect of fusion and satisfaction rates could not be comprehensively investigated. This is attributable to the retrospective nature of the study. Therefore, future prospective studies should address the issue in a more detailed approach by accommodating different parameters.

### Conclusion

Several alternatives to the surgical treatment exist intended for low-grade spondylolisthesis. The widespread use of a modern and contemporary stabilization technique, including the posterior pedicle screw in orthopedics and neurosurgery, has opened new horizons in spinal surgery. The fusion rates have increased and better stabilization can be achieved through the pedicle screw technique. It is widely accepted that the most effective stabilization can be provided using fusion. Therefore, the combination of pedicle screw fixation and fusion, with the addition of decompression, as necessary, may be considered the ideal surgical method. However, patient selection is one of the most important aspects of treatment. Previous surgery is an important risk factor that should be considered before deciding the surgical treatment. In conclusion, it is possible to make use of the transpedicular screw fixation technique in a less complicated and effective approach through an effective and experienced teamwork.

### Conflict Of Interest

The authors declared they do not have anything to disclose regarding conflict of interest with respect to this manuscript.

### References

1. Santoni BG, Hynes RA, McGilvray KC, Rodriguez-Canessa G, Lyons AS, Henson MA, et al. Cortical bone trajectory for lumbar pedicle screws. *Spine J.* 2009;9:366-73.
2. Holly LT, Foley KT. Three-dimensional fluoroscopy-guided percutaneous thoracolumbar pedicle screw placement. Technical note. *J Neurosurg.* 2003;99;Suppl:324-9.
3. Lee CK, Park JY, Zhang HY. Minimally invasive transforaminal lumbar interbody fusion using a single interbody cage and a tubular retraction system: technical tips, and perioperative, radiologic and clinical outcomes. *J Korean Neurosurg Soc.* 2010;48:219-24.
4. Grob D, Humke T, Dvorak J. Direct pediculo-body fixation in cases of spondylolisthesis with advanced intervertebral disc degeneration. *Eur Spine J.* 1996;5:281-5.
5. Wang SJ, Han YC, Liu XM, Ma B, Zhao WD, Wu DS, et al. Fusion techniques for adult isthmic spondylolisthesis: a systematic review. *Arch Orthop Trauma Surg.* 2014;134:777-84.
6. Aimar E, Iess G, Mezza F, Gaetani P, Messina AL, Todesca A, et al. Complications of degenerative lumbar spondylolisthesis and stenosis surgery in patients over 80 s: comparative study with over 60 s and 70 s. Experience with 678 cases. *Acta Neurochir (Wien).* 2022;164:923-31.
7. Fehlings MG, Rabin D. Surgical complications in adult spondylolisthesis. *J Neurosurg Spine.* 2010;13:587-8; discussion 588.
8. Kirkaldy-Willis WH, Paine KW, Cauchoix J, McLvor G. Lumbar spinal stenosis. *Clin Orthop Relat Res.* 1974;(99):30-50.
9. Taillard WF. Etiology of spondylolisthesis. *Clin Orthop Relat Res.* 1976;(117):30-39.
10. Austevoll IM, Gjestad R, Solberg T, Storheim K, Brox JI, Hermansen E, et al. Comparative effectiveness of microdecompression Alone vs decompression plus instrumented fusion in lumbar degenerative spondylolisthesis. *JAMA Netw Open.* 2020;3:e2015015.
11. Chen SR, Gibbs CM, Zheng A, Dalton JF, Gannon EJ, Shaw JD, et al. Use of L5-S1 transdiscal screws in the treatment of isthmic spondylolisthesis: a technical note. *J Spine Surg.* 2021;7:510-5.

12. Zayan M, Hussien MA, El Zahlawy H. Pars interarticularis repair using pedicle screws and laminar hooks fixation technique in patients with symptomatic lumbar spondylolysis. *SICOT J*. 2022;8:13.
13. Pai VS, Hodgson B, Pai V. Repair of spondylolytic defect with a cable screw reconstruction. *Int Orthop*. 2008;32:121-5.
14. Tang L, Wu Y, Jing D, Xu Y, Wang C, Pan J. A Bayesian network meta-analysis of 5 different fusion surgical procedures for the treatment of lumbar spondylolisthesis. *Med (Baltim)*. 2020;99:e19639.
15. Bydon M, Alvi MA, Goyal A. Degenerative lumbar spondylolisthesis: definition, natural history, conservative management, and surgical treatment. *Neurosurg Clin N Am*. 2019;30:299-304.
16. Dunn AS, Baylis S, Ryan D. Chiropractic management of mechanical low back pain secondary to multiple-level lumbar spondylolysis with spondylolisthesis in a United States Marine Corps veteran: a case report. *J Chiropr Med*. 2009;8:125-30.
17. Boyd ED, Mundluru SN, Feldman DS. Outcome of conservative management in the treatment of symptomatic spondylolysis and Grade I spondylolisthesis. *Bull Hosp Jt Dis (2013)* 2019;77:172-82.
18. Nava-Bringas TI, Romero-Fierro LO, Trani-Chagoya YP, Macías-Hernández SI, García-Guerrero E, Hernández-López M, et al. Stabilization exercises versus flexion exercises in degenerative spondylolisthesis: A randomized controlled trial. *Phys Ther*. 2021;101:pzab108.
19. Matsunaga S, Sakou T, Morizono Y, Masuda A, Demirtas AM. Natural history of degenerative spondylolisthesis. Pathogenesis and natural course of the slippage. *Spine (Phila Pa 1976)*. 1990;15:1204-10.
20. Eismont FJ, Norton RP, Hirsch BP. Surgical management of lumbar degenerative spondylolisthesis. *J Am Acad Orthop Surg*. 2014;22:203-13.
21. Mori G, Mikami Y, Arai Y, Ikeda T, Nagae M, Tonomura H, et al. Outcomes in cases of lumbar degenerative spondylolisthesis more than 5 years after treatment with minimally invasive decompression: examination of pre- and postoperative slippage, intervertebral disc changes, and clinical results. *J Neurosurg Spine*. 2016;24:367-74.
22. Kimura R, Yoshimoto M, Miyakoshi N, Hongo M, Kasukawa Y, Kobayashi T, et al. Comparison of posterior lumbar interbody fusion and microendoscopic muscle-preserving interlaminar decompression for degenerative lumbar spondylolisthesis with >5-year follow-up. *Clin Spine Surg*. 2019;32:E380-5.
23. Jang JW, Park JH, Hyun SJ, Rhim SC. Clinical outcomes and radiologic changes after microsurgical bilateral decompression by a unilateral approach in patients with lumbar spinal stenosis and Grade I degenerative spondylolisthesis with a minimum 3-year follow-up. *Clin Spine Surg*. 2016;29:268-71.
24. Müslüman AM, Cansever T, Yılmaz A, Çavuşoğlu H, Yüce İ, Aydın Y. Midterm outcome after a microsurgical unilateral approach for bilateral decompression of lumbar degenerative spondylolisthesis. *J Neurosurg Spine*. 2012;16:68-76.
25. Pazarlis K, Frost A, Försth P. Lumbar spinal stenosis with degenerative spondylolisthesis treated with decompression Alone. A cohort of 346 patients at a large spine unit. Clinical outcome, complications and subsequent surgery. *Spine (Phila Pa 1976)*. 2022;47:470-5.
26. Ghogawala Z, Dziura J, Butler WE, Dai F, Terrin N, Magge SN, et al. Laminectomy plus Fusion versus laminectomy Alone for Lumbar spondylolisthesis. *N Engl J Med*. 2016;374:1424-34.
27. Tsutsumimoto T, Shimogata M, Yoshimura Y, Misawa H. Union versus nonunion after posterolateral lumbar fusion: a comparison of long-term surgical outcomes in patients with degenerative lumbar spondylolisthesis. *Eur Spine J*. 2008;17:1107-12.
28. Martin CR, Gruszczynski AT, Braunsfurth HA, Fallatah SM, O'Neil J, Wai EK. The surgical management of degenerative lumbar spondylolisthesis: a systematic review. *Spine (Phila Pa 1976)*. 2007;32:1791-8.
29. Endler P, Ekman P, Möller H, Gerdhem P. Outcomes of posterolateral fusion with and without instrumentation and of interbody fusion for isthmic spondylolisthesis: A prospective study. *J Bone Joint Surg Am*. 2017;99:743-52.
30. Ye YP, Chen D, Xu H. The comparison of instrumented and non-instrumented fusion in the treatment of lumbar spondylolisthesis: a meta-analysis. *Eur Spine J*. 2014;23:1918-26.
31. Cruz A, Ropper AE, Xu DS, Bohl M, Reece EM, Winocour SJ, et al. Failure in lumbar spinal fusion and current management modalities. *Semin Plast Surg*. 2021;35:54-62.
32. Jalanko T, Helenius I, Remes V, Lamberg T, Tervahartiala P, Yrjönen T, et al. Operative treatment of isthmic spondylolisthesis in children: a long-term, retrospective comparative study with matched cohorts. *Eur Spine J*. 2011;20:766-75.
33. Voor MJ, Mehta S, Wang M, Zhang YM, Mahan J, Johnson JR. Biomechanical evaluation of

posterior and anterior lumbar interbody fusion techniques. *J Spinal Disord*. 1998;11:328-34.

34. DiPaola CP, Molinari RW. Posterior lumbar interbody fusion. *J Am Acad Orthop Surg*. 2008;16:130-9.

35. Guppy KH, Royse KE, Norheim EP, Harris JE, Brara HS. PLF versus PLIF and the fate of L5-S1: analysis of operative nonunion rates among 3065 patients with lumbar fusions from a regional spine registry. *Spine (Phila Pa 1976)*. 2021;46:E584-93.

36. Okuda S, Fujimori T, Oda T, Maeno T, Yamashita T, Matsumoto T, et al. Factors associated with patient satisfaction for PLIF: patient satisfaction analysis. *Spine Surg Relat Res*. 2017;1:20-6.

37. Liu X, Wang Y, Qiu G, Weng X, Yu B. A systematic review with meta-analysis of posterior interbody fusion versus posterolateral fusion in lumbar spondylolisthesis. *Eur Spine J*. 2014;23:43-56.

38. Kim KT, Lee SH, Lee YH, Bae SC, Suk KS. Clinical outcomes of 3 fusion methods through the posterior approach in the lumbar spine. *Spine (Phila Pa 1976)*. 2006;31:1351-7; discussion 1358.

39. Fritzell P, Hägg O, Wessberg P, Nordwall A, Swedish Lumbar Spine Study Group. Chronic low back pain and fusion: a comparison of three surgical techniques: a prospective multicenter randomized study from the Swedish lumbar spine study group. *Spine (Phila Pa 1976)*. 2002;27:1131-41.

40. Inamdar DN, Alagappan M, Shyam L, Devadoss S, Devadoss A. Posterior lumbar interbody fusion versus intertransverse fusion in the treatment of lumbar spondylolisthesis. *J Orthop Surg (Hong Kong)*. 2006;14:21-6.

41. Hallett A, Huntley JS, Gibson JN. Foraminal stenosis and single-level degenerative disc disease: a randomized controlled trial comparing decompression with decompression and instrumented fusion. *Spine (Phila Pa 1976)*. 2007;32:1375-80.

42. Fischgrund JS, Mackay M, Herkowitz HN, Brower R, Montgomery DM, Kurz LT. 1997 Volvo Award winner in clinical studies. Degenerative lumbar spondylolisthesis with spinal stenosis: a prospective, randomized study comparing decompressive laminectomy and arthrodesis with and without spinal instrumentation. *Spine (Phila Pa 1976)*. 1997;22:2807-12.

43. Gruskay JA, Webb ML, Grauer JN. Methods of evaluating lumbar and cervical fusion. *Spine J*. 2014;14:531-9.

44. Li Y, Zheng LM, Zhang ZW, He CJ. The effect of smoking on the fusion rate of spinal fusion surgery: A systematic review and meta-analysis. *World Neurosurg*. 2021;154:e222-35.

45. Luszczyk M, Smith JS, Fischgrund JS, Ludwig SC, Sasso RC, Shaffrey CI, et al. Does smoking have an impact on fusion rate in single-level anterior cervical discectomy and fusion with allograft and rigid plate fixation? Clinical article. *J Neurosurg Spine*. 2013;19:527-31.

46. Cummins D, Hindoyan K, Wu HH, Theologis AA, Callahan M, Tay B, et al. Reoperation and mortality rates following elective 1 to 2 level lumbar fusion: A large state database analysis. *Glob Spine J*. 2022;12:1708-14.

47. Suh SP, Jo YH, Jeong HW, Choi WR, Kang CN. Outcomes of revision surgery following instrumented posterolateral fusion in degenerative lumbar spinal stenosis: A comparative analysis between pseudarthrosis and adjacent segment disease. *Asian Spine J*. 2017;11:463-71.

48. Derman PB, Singh K. Surgical strategies for the treatment of lumbar pseudarthrosis in degenerative spine surgery: A literature review and case study. *HSS J*. 2020;16:183-7.

49. Schimmel JJ, Horsting PP, de Kleuver M, Wonders G, van Limbeek J. Risk factors for deep surgical site infections after spinal fusion. *Eur Spine J*. 2010;19:1711-9.